

INTERGRATED AV AMPLIFIER

KA-894/994/V3700

SERVICE MANUAL

KENWOOD

4110

©1994-1 PRINTED IN KOREA
B51-4846-00(K)3576

(KA-994)

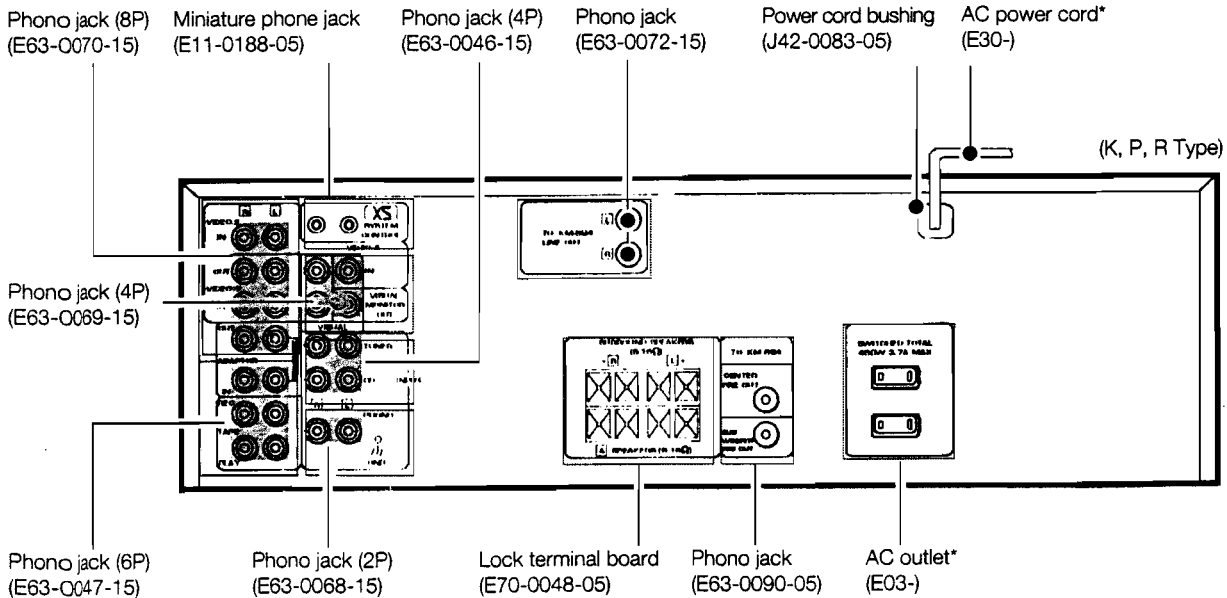
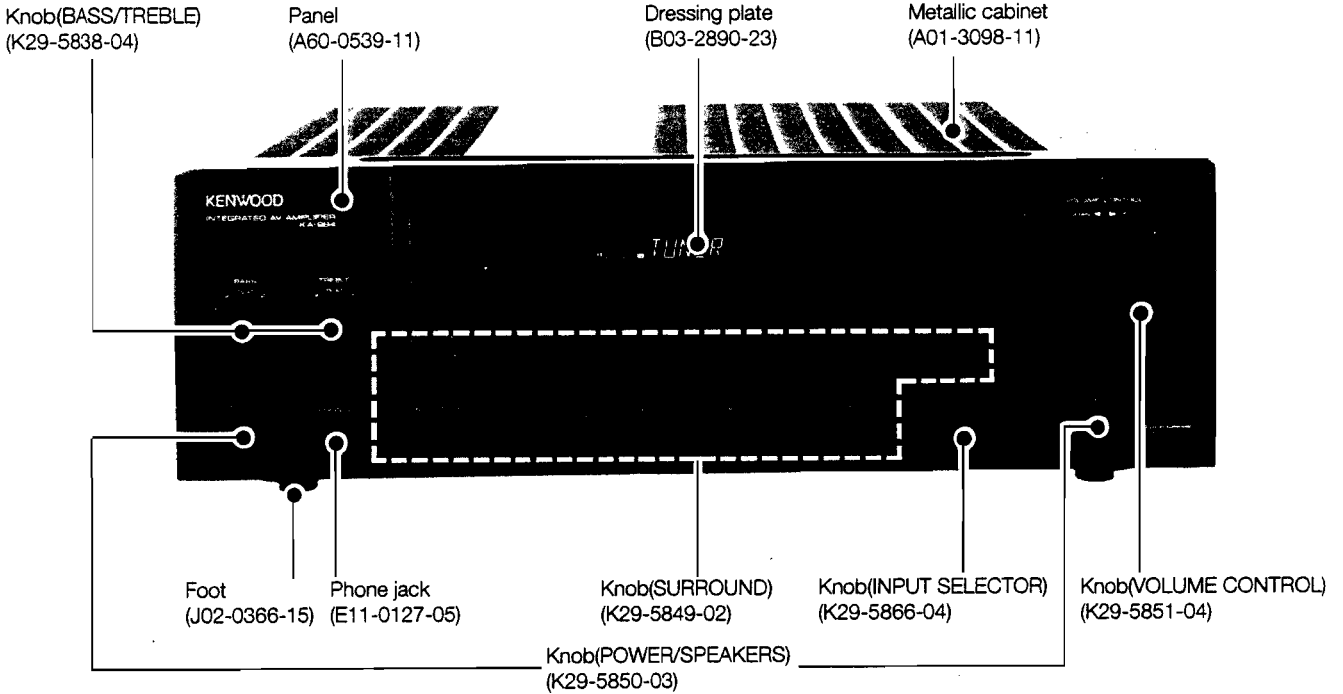

*Refer to parts list on page 34.

4110

CONTENTS

ACCESSORIES	2	PC BOARD	15
REMOTE CONTROL	4	SCHEMATIC DIAGRAM	23
BLOCK DIAGRAM	6	EXPLODED VIEW	33
CIRCUIT DESCRIPTION	7	PARTS LIST	34
ADJUSTMENT	13	SPECIFICATIONS	43
WIRING DIAGRAM	14		

ACCESSORIES

- Remote control unit1
(A70-0974-05) KA-894/V3700

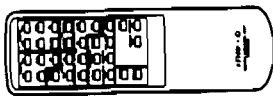

Battery cover (A09-0170-08)

RC-S0800

- AC plug adaptor1
(E03-0115-05)
KA-994, 894(M)

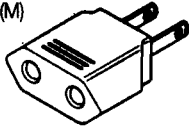

(A70-0961-05) KA-994

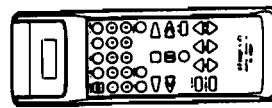

Battery cover (A09-0169-08)

RC-R0801

- Batteries(R6/AA)2
(-)

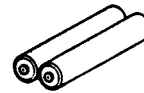

(KA-894 / V3700)

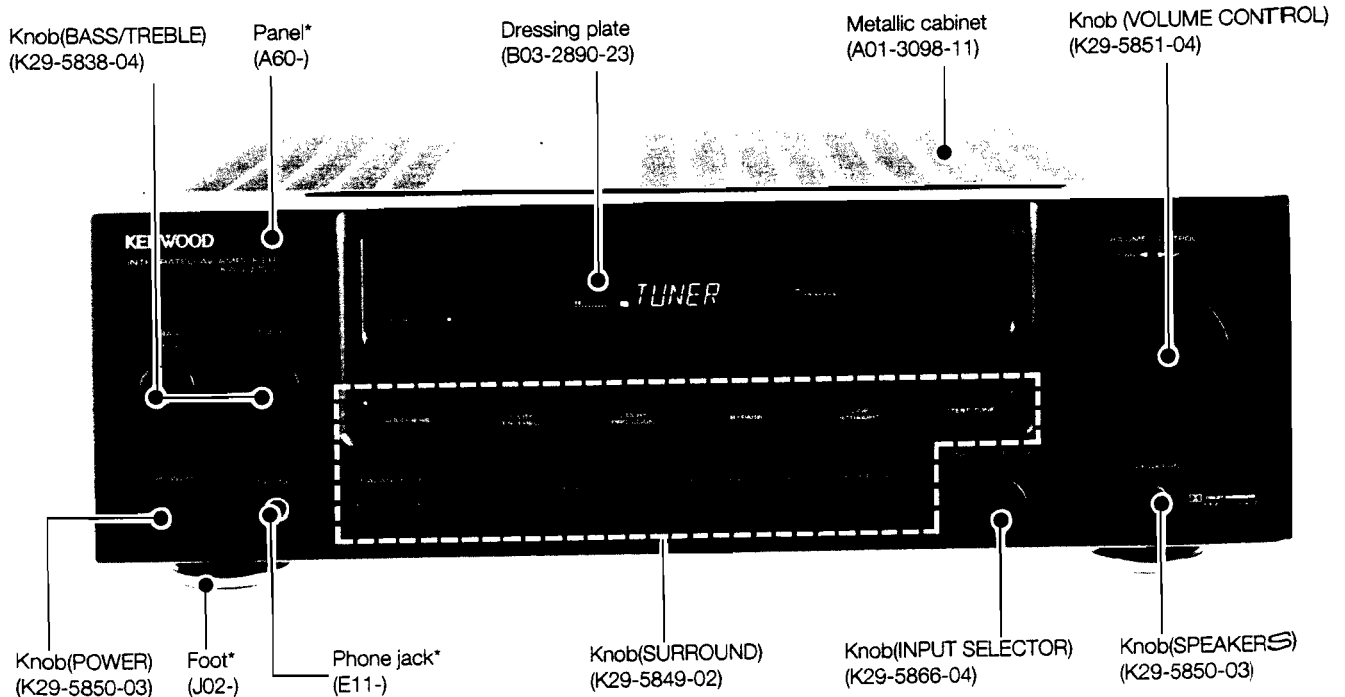
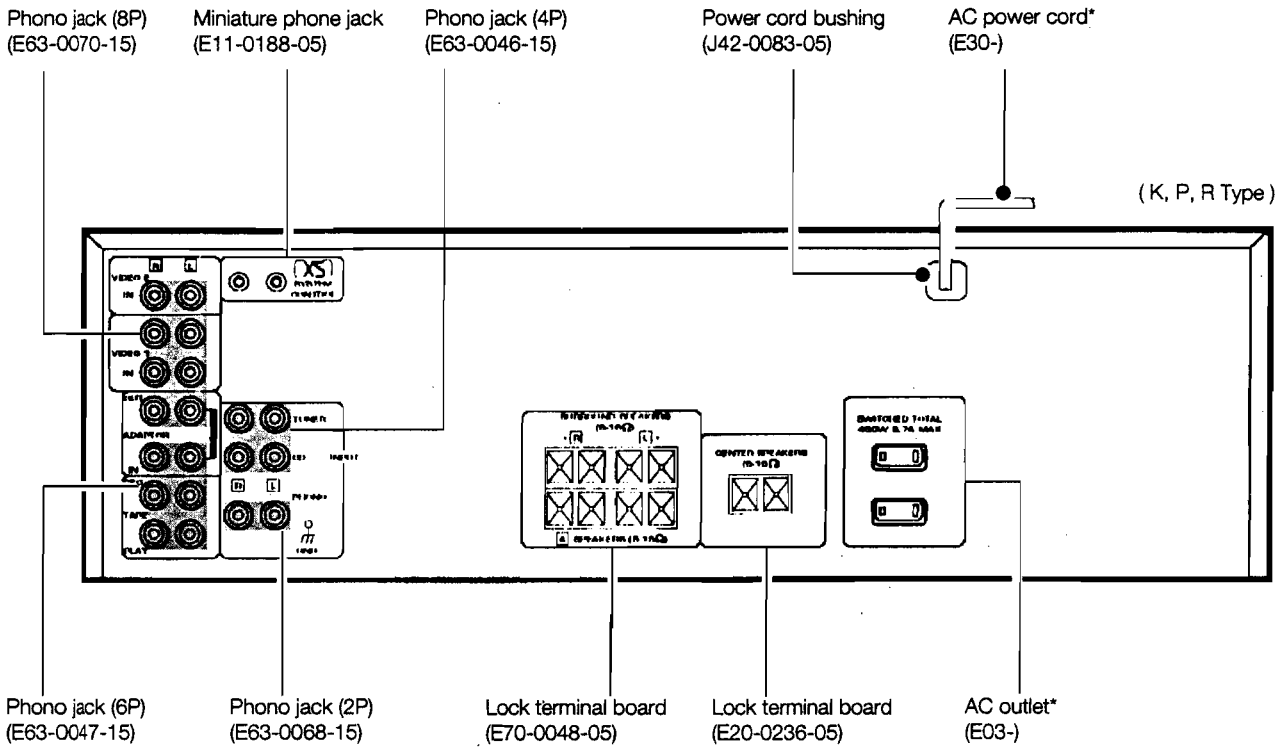

Photo is KA-V3700.

*Refer to parts list on page 34.

(KA-894)



(KA-V3700)

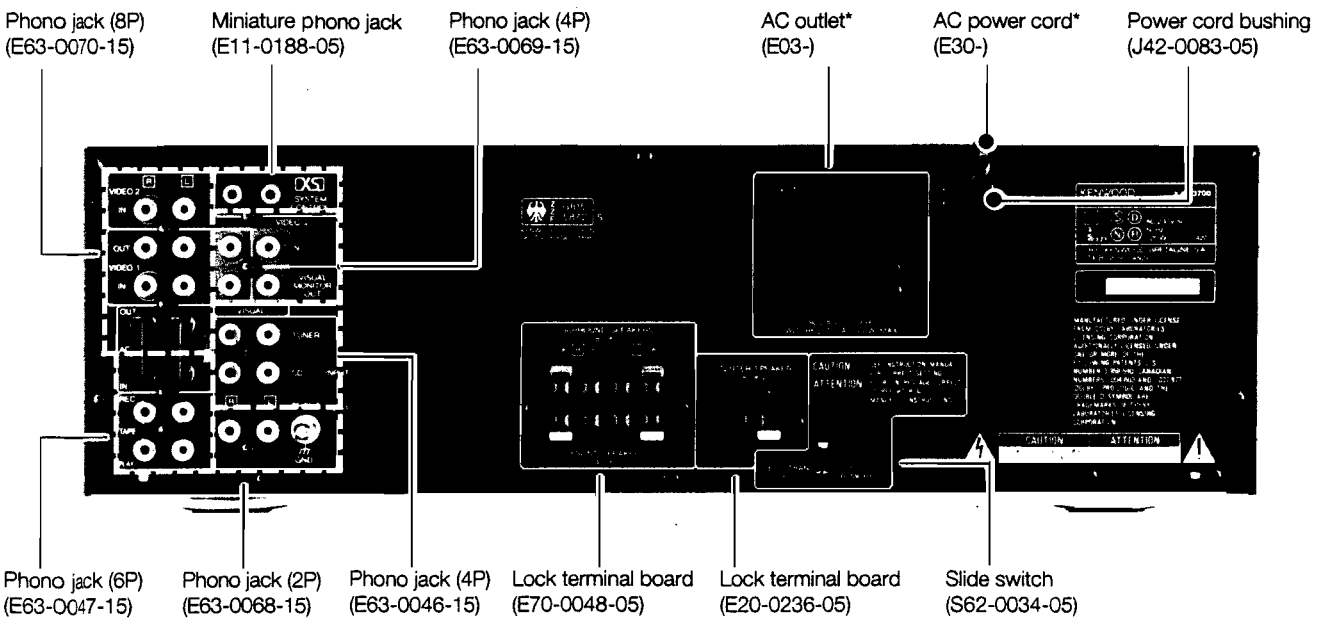

*Refer to parts list on page 34.

REMOTE CONTROL

REMOTE CONTROL ASSY : A70-0961-05 (KA-994)

Operating the KR-V8060 or KA-994

1. Press the **AUDIO** key to display "AUDIO".
2. Press the **POWER** key to turn the power of the main unit (KR-V8060 or KA-994) ON.
3. Press operation keys.

* The keys covered with  are not used in the operation of the receiver.

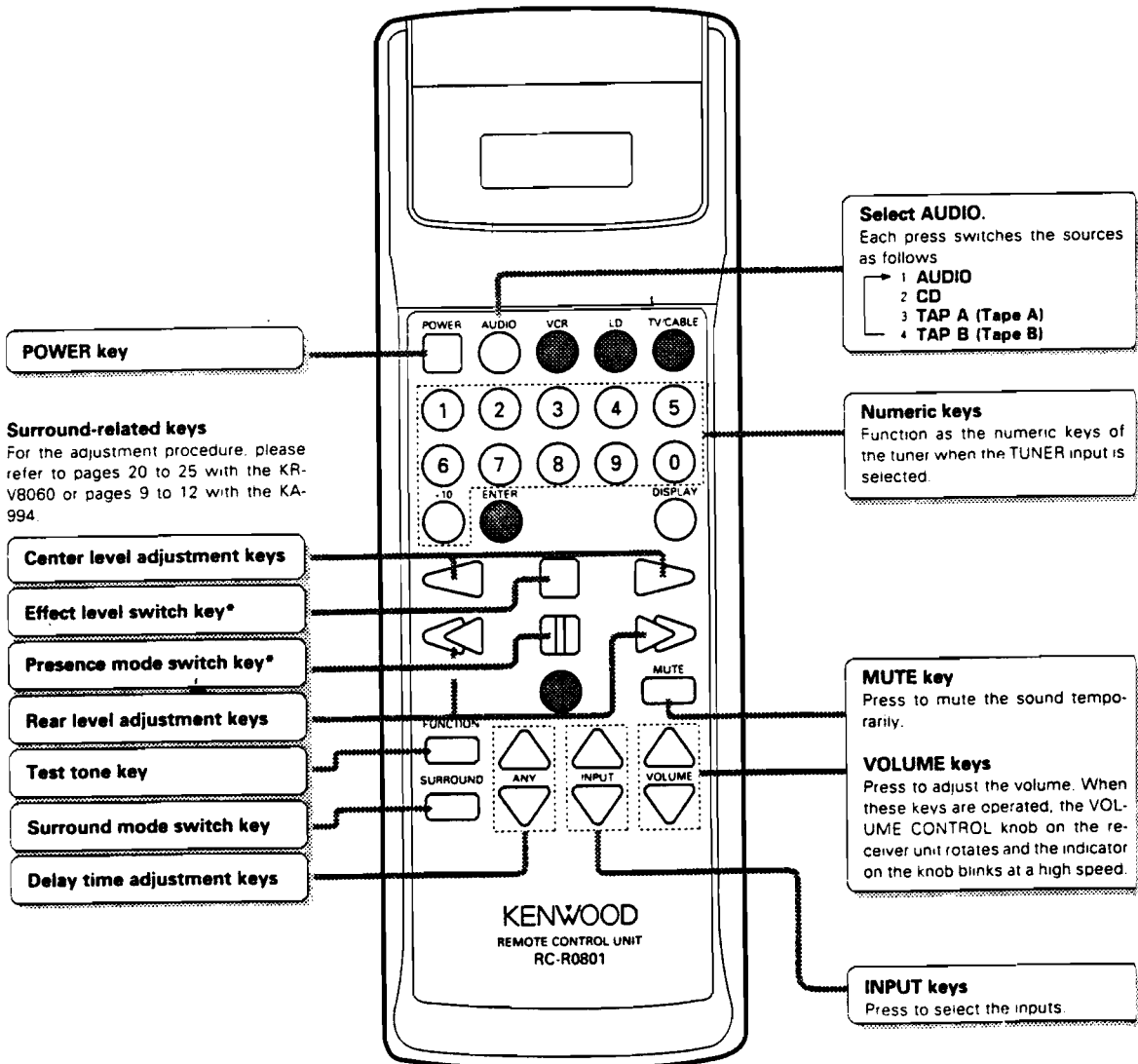

Model: RC-R0801
Infrared ray system

REMOTE CONTROL ASSY : A70-0974-05 (KA-894/V3700)

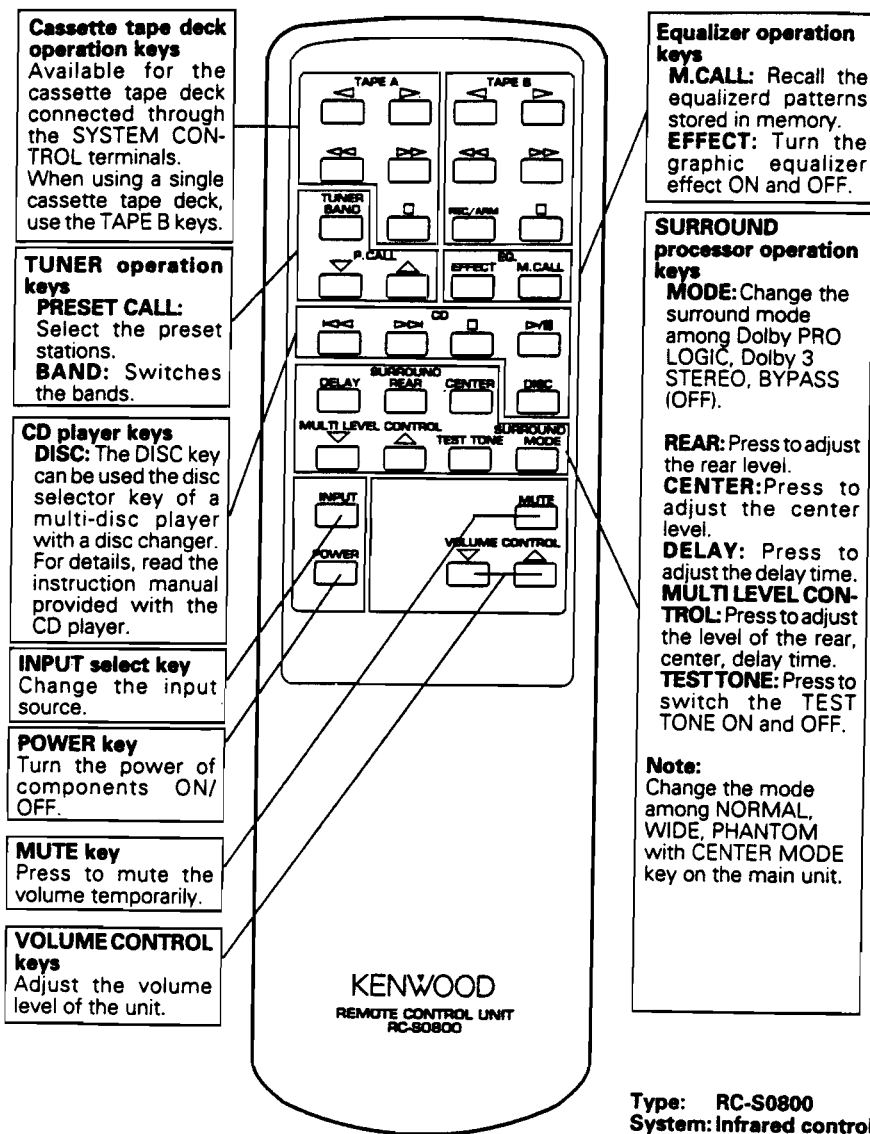

BLOCK DIAGRAM

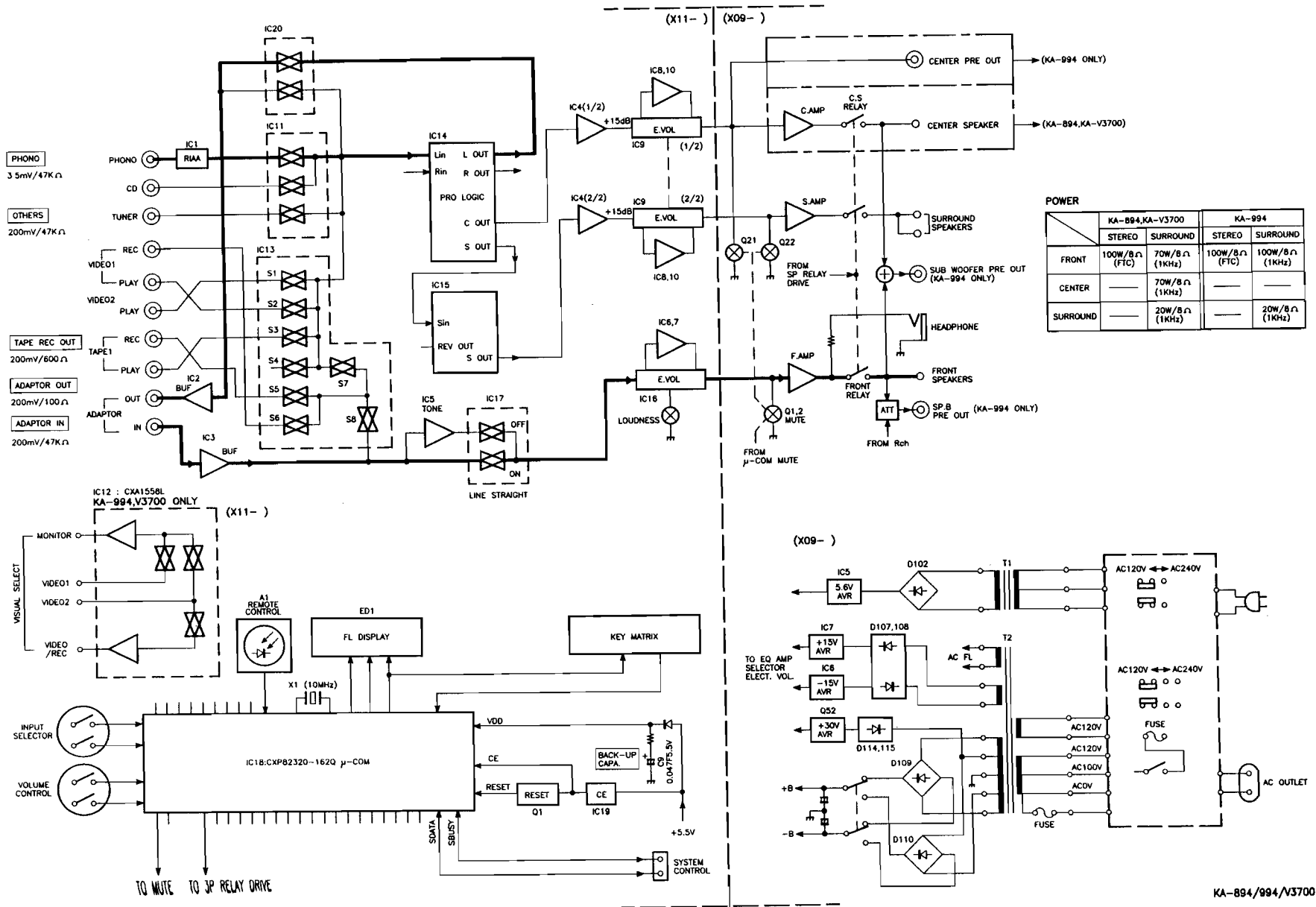

CIRCUIT DESCRIPTION

TEST MODE

① To get in the TEST MODE

Plug the AC power cord in the wall outlet while pushing the SPEAKERS key.

All indications light up.

② To cancel the TEST MODE

Unplug the AC power cord from the wall outlet.

③ Operation during the TEST MODE

<1> The TEST MODE starts with all indications lit up and with POWER ON.

- ◇ The Light up state returns to the normal operation state when any key of the main unit is pushed.

<2> Keys that have different functions from their normal functions in the test mode

BALANCE L	Three steps change from R to Center to L.
BALANCE R	Three steps change from L to Center to R.
DELAY TIME +	Three steps change from Minimum to Center to Maximum.
DELAY TIME -	Three steps change from Maximum to Center to Minimum.
CENTER LEVEL +	Three steps change from Minimum to Center to Maximum.
CENTER LEVEL -	Three steps change from Maximum to Center to Minimum.
REAR LEVEL +	Three steps change from Minimum to Center to Maximum.
REAR LEVEL -	Three steps change from Maximum to Center to Minimum.
8Ω/4Ω Switch	Switch status is indicated by TAPE 2 display. 8Ω: TAPE 2 display goes off. 4Ω: TAPE 2 display lights up. At any time TAPE 2 display is indicated, however H/L switch of 70W/100W control port (pin no.9) is switched when. . . Power ON or OFF SPEAKER ON or OFF DOLBY Mode or BYPASS Switching with INPUT SELECTOR

INITIAL SETTING

① Initial setting

Plug the AC power cord in the wall outlet while pushing the SPEAKERS key.

- ◇ All memorys are cleared.
- ◇ The backup operation is returned to the normal operation.

SERIAL TEST MODE

① To get in the SERIAL TEST MODE

Enter the TEST ON code (71).

② To cancel the SERIAL TEST MODE

Enter the TEST OFF code (70), unplug the AC power cord from the electrical outlet, or RESET the equipment.

- ◇ The operation returns from the test mode to the normal mode.

③ Operation during the SERIAL TEST MODE

- The following functions become ineffective during the test mode.
 - ◇ Keys of the main unit, keys of the remote controller, ordinary serial codes.
 The same codes as the received ones are outputted.
- Output of the MUTE signal.
 - ◇ The MUTE function does not work during the SERIAL TEST MODE. The operation of the MUTE function is checked with a specific code.
- Codes received during the SERIAL TEST MODE are effective irrespective of the display mode.
- The key entry inhibit state with 16-second duration is not available when the ADAPTOR is turned ON/OFF.
- When the initial setting is carried out by means of the initial setting AMP (3F) and the initial setting GE (DF) code.
 - ◇ SPEAKERS A/B turn OFF in response to software operation.

CIRCUIT DESCRIPTION

8 bit SERIAL TEST CODE

FUNCTION CODE	AMP			TUNER			SURROUND			GE						
	0	1	2	3	4	5	6	7	8	9	A	B	C	D	E	F
0	POWER OFF	CD DIRECT OFF	SP B OFF		POWER OFF	0	MEMORY	TEST OFF	POWER OFF	REAR MUTE ON	ASFC MAX	ACOUSTIC BGM	POWER OFF			
1	POWER ON	CD DIRECT ON	SP B ON		POWER ON	1	MAIN	TEST ON	POWER ON	MUTE ALL OFF	SEAT POS MIN	CINEMA SCREEN OFF	POWER ON			
2	PHONO	CD REC OFF	HIT MASTER OFF		MUTE OFF	2	SUB		BYPASS	CENTER LEVEL MIN	SEAT POS MID	CINEMA SCREEN 1	MUTE OFF			
3	CD	CD REC ON	HIT MASTER ON		MUTE ON	3	BOTH		DOLBY SUR-ROUND	CENTER LEVEL MID	SEAT POS MAX	CINEMA SCREEN 2	MUTE ON			
4	TUNER	SOURCE DIRECT OFF	MOTOR VOL UP		AUTO STEREO	4			DOLBY 3 STEREO	CENTER LEVEL MAX	WALL MIN	CINEMA SCREEN 3	EQ OFF			
5	TAPE 1 (TAPE A)	SOURCE DIRECT ON	MOTOR VOL DOWN		MONO	5			DSP	REAR LEVEL MIN	WALL MID	CH.MODE 2	EQ ON			
6	TAPE 2 (TAPE B)	LINE STRAIGHT OFF	MOTOR VOL STOP		TUNED OFF	6			DSP LOGIC	REAR LEVEL MID	WALL MAX	CH.MODE 3	M1 (ALL MID)			
7	AUX	LINE STRAIGHT ON	DBS/TV ON		TUNED ON	7			S.4CH	REAR LEVEL MAX	ROOM SIZE MIN	CH.MODE 4	M2 (ALL MAX)			
8	DAT	LOUDNESS OFF	VR 0dB		A.R OFF	8			F.4CH	DILAY TIME MIN	ROOM SIZE MID	CH.MODE 5	M3 (ALL MIN)			
9	VIDEO 1 (VIDEO)	LOUDNESS ON	-20dB		A.R ON	9			CENTER MODE NORMAL	DILAY TIME MID	ROOM SIZE MAX					
A	VIDEO 2	SUB SONIC OFF	-30dB		RF DIRECT	+10			CENTER MODE WIDE	DILAY TIME MAX	STEREO (KARAOKE)					
B	VIDEO 3	SUB SONIC ON	-70dB		RF DISTANCE	BAND FM			CENTER MODE PHANTOM	PRESENCE LEVE (EFFECT)MIN	MULTI (KARAOKE)					
C	VDP	S WOOFER OFF	∞		IF WIDE	BAND AM/MW			TEST TONE OFF	PRESENCE LEVE (EFFECT)MID	HFI MULTI (KARAOKE)					
D	MUTE ON	S WOOFER ON	BALANCE L	ALL LIGHT UP ON	IF NORMAL	BAND TV/LW			TEST TONE ON	PRESENCE LEVE (EFFECT)MAX	NORMAL (KARAOKE)			ALL LIGHT UP ON		
E	SELMUTE ON	SP OFF (SP A OFF)	BALANCE C	ALL LIGHT UP OFF	IF NARROW	DOWN			FRONT MUTE ON	ASFC MIN	ACOUSTIC NON DIRE 1			ALL LIGHT UP OFF		
F	MUTE ALL OFF	SP ON (SP A ON)	BALANCE R	INITIAL SETTING (AMP)	DIRECT	UP			CENTER MUTE ON	ASFC MID	ACOUSTIC NON DIRE 2	INITIAL SETTING (SURROUND)		INITIAL SETTING (GE)		

CIRCUIT DESCRIPTION

KEY MATRIX

	KRO	KRI	KR2		
FL. A. p/KS00	—	CENTER SPEAKER VOLUME DOWN	Dolby 3-Stereo	S20	54pin
FL. A. n/KS01	CENTER MODE	CENTER SPEAKER VOLUME UP	Dolby Pro Logic	S19	53pin
FL. A. m/KS02	BALANCE R	REAR SPEAKER VOLUME DOWN	BYPASS	S18	52pin
FL. A. k/KS03	BALANCE L	REAR SPEAKER VOLUME UP	LOUDNESS	S17	51pin
FL. A. j/KS04	TEST-TONE	DELAY TIME DOWN	LINE- STRAIGHT	S16	50pin
FL. A. a/KS05	SPEAKER ON/OFF	DELAY TIME UP	POWER	PF7/S15	49PIN
FL. A. b/T. o/KS06				PF6/S14	48PIN
FL. A. h/T. n/KS07				PF5/S13	47PIN
FL. A. f/T. m/KS08				PF4/S12	46PIN
FL. A. g/T. l/KS09				PF3/S11	45PIN
FL. A. d/T. k/KS10				PF2/S10	44PIN
FL. A. c/T. j/KS11				PF1/S09	43PIN
FL. A. e/T. i/KS _{INI1}				PF0/S08	42PIN
FL. T. h/KS _{INI2}	DSW3	DSW4	DSW5	PD7/S07	41PIN
	PC0/KRO 14pin	PC1/KR1 15pin	PC2/KR2 16pin		

	DSW3	DSW4	DSW5
KA-894	NO	NO	NO
KA-994	NO	YES	YES
KA-V3700	NO	YES	YES

CIRCUIT DESCRIPTION

PIN LAYOUT MICRO PROCESSOR CXP82320-158Q <BOTTOM VIEW>

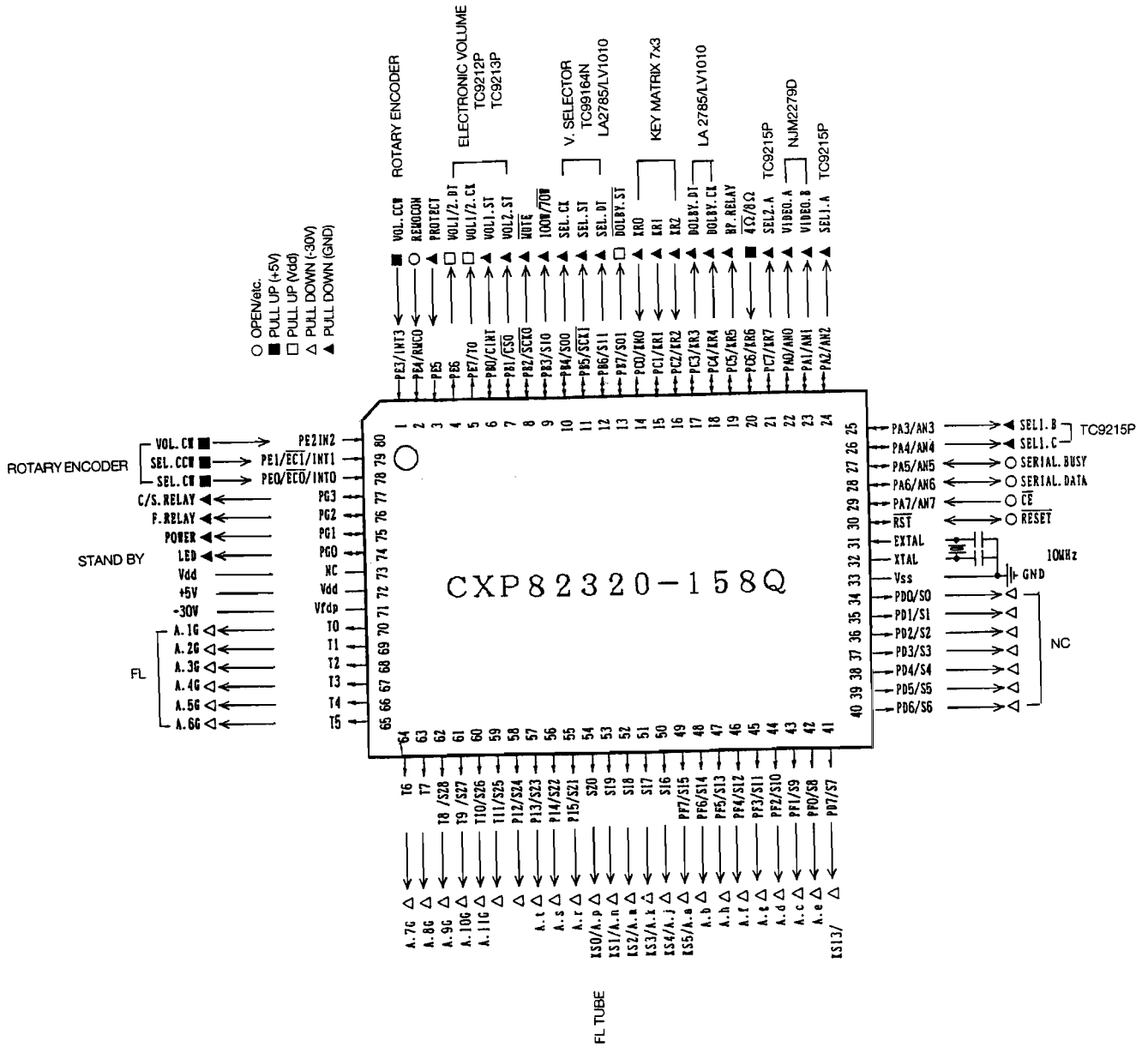

CIRCUIT DESCRIPTION

Pin description

Pin No.	Pin Name	I/O	Name	Description
1	PE3/INT3	I	VOL. CCW	Input of ROTARY ENCODER PHASE B signal for VOLUME
2	PE4/RMC	I	REMOCON	REMOTE CONTROLLER signal input
3	PE5	I	PROTECT	PROTECTION control signal input
4	PE6	O	VOL1/2. DT	Output of DATA signal for control of electronic VOLUME (TC9212P/TC9213P)
5	PE7/T0	O	VOL1/2. CK	Output of CLOCK signal for control of electronic VOLUME (TC9212P/TC9213P)
6	PB0/CINT	O	VOL1. ST	Output of STROBE signal for control of electronic VOLUME (TC9212P/TC9213P)
7	PB1/CS0	O	VOL2. ST	Output of STROBE signal for control of electronic VOLUME (TC9213P)
8	PB2/SCK0	O	MUTE	MUTING circuit control signal output L:ON, H:OFF
9	PB3/SI0	O	100W/70W	100W/70W RELAY control signal output L:70W, H:100W
10	PB4/SO0	O	SEL. CK	Output CLOCK signal for control of SELECTOR (TC9164N)
11	PB5/SCK1	O	SEL. ST	Output STROBE signal for control of SELECTOR (TC9164N)
12	PB6/SI1	O	SEL. DT	Output DATA signal for control of SELECTOR (TC9164N)
13	PB7/SO1	O	DOLBY. ST	Output of ENABLE signal for control of DOLBY IC (LA2785/LV1010)
14	PC0/KR0	I	KR0	KEY RETURN signal input
15	PC1/KR1	I	KR1	KEY RETURN signal input
16	PC2/KR2	I	KR2	KEY RETURN signal input
17	PC3/KR3	O	DOLBY. DT	Output of DATA signal for control of DOLBY IC (LA2785/LV1010)
18	PC4/KR4	O	DOLBY. CK	Output of CLOCK signal for control of DOLBY IC (LA2785/LV1010)
19	PC5/KR5	O	HP. RELAY	HEADPHONE RELAY control signal output (LC7218)
20	PC6/KR6	O	4Ω / 8Ω	Speaker impedance switching (LC7218)
21	PC7/KR7	O	SEL2. A	LINE STRAIGHT control signal output (TC9215P)
22	PA0/AN0	O	VIDEO. A	VIDEO SELECTOR A control signal output (NJM2279D)
23	PA1/AN1	O	VIDEO. B	VIDEO SELECTOR B control signal output (NJM2279D)
24	PA2/AN2	O	SEL1. A	LINE STRAIGHT control signal output (TC9215P)
25	PA3/AN3	O	SEL1. B	PHONO select signal output (TC9215P)
26	PA4/AN4	O	SEL1. C	CD/TUNER select signal output (TC9215P)
27	PA5/AN5	I/O	SERIAL. BUSY	System serial BUSY signal input/output
28	PA6/AN6	I/O	SERIAL. DATA	System serial DATA signal input/output
29	PA7/AN7	I	\overline{CE}	BACK UP detection
30	RST	I/O	RESET	RESET signal detection
31	EXTAL	I		System Clock input (10MHz)
32	XTAL			System Clock (10MHz)
33	Vss			GND
34	PD0/S0	O	T.a	Unused
35	PD1/S1	O	T.b	Unused
36	PD2/S2	O	T.c	Unused
37	PD3/S3	O	T.d	Unused
38	PD4/S4	O	T.e	Unused
39	PD5/S5	O	T.f	Unused
40	PD6/S6	O	T.g	Unused

CIRCUIT DESCRIPTION

Pin description

Pin No.	Pin Name	I/O	Name	Description
41	PD7/S7	O	KS13	KEY SCAN 13 signal output
42	PF0/S8	O	A.e	FL tube segment e(pin no.35) driving signal output
43	PF1/S9	O	A.c	FL tube segment c(pin no.34) driving signal output
44	PF2/S10	O	A.d	FL tube segment d(pin no.33) driving signal output
45	PF3/S11	O	A.g	FL tube segment g(pin no.32) driving signal output
46	PF4/S12	O	A.f	FL tube segment f(pin no.31) driving signal output
47	PF5/S13	O	A.h	FL tube segment h(pin no.30) driving signal output
48	PF6/S14	O	A.b	FL tube segment b(pin no.29) driving signal output
49	PF7/S15	O	KS5/A.a	KEY SCAN 5 signal output FL tube segment a(pin no.28) driving signal output
50	S16	O	KS4/A.j	KEY SCAN 4 signal output FL tube segment j(pin no.27) driving signal output
51	S17	O	KS3/A.k	KEY SCAN 3 signal output FL tube segment k(pin no.26) driving signal output
52	S18	O	KS2/A.m	KEY SCAN 2 signal output FL tube segment m(pin no.25) driving signal output
53	S19	O	KS1/A.n	KEY SCAN 1 signal output FL tube segment n(pin no.24) driving signal output
54	S20	O	KS0/A.p	KEY SCAN 0 signal output FL tube segment p(pin no.23) driving signal output
55	T15/S21	O	A.r	FL tube segment r(pin no.22) driving signal output
56	T14/S22	O	A.s	FL tube segment s(pin no.21) driving signal output
57	T13/S23	O	A.t	FL tube segment t(pin no.20) driving signal output
58	T12/S24	O		Unused
59	T11/S25	O		Unused
60	T10/S26	O	A.11G	FL tube segment 11G(pin no.15) driving signal output
61	T9/S27	O	A.10G	FL tube segment 10G(pin no.14) driving signal output
62	T8/S28	O	A.9G	FL tube segment 9G(pin no.13) driving signal output
63	T7	O	A.8G	FL tube segment 8G(pin no.12) driving signal output
64	T6	O	A.7G	FL tube segment 7G(pin no.11) driving signal output
65	T5	O	A.6G	FL tube segment 6G(pin no.10) driving signal output
66	T4	O	A.5G	FL tube segment 5G(pin no.9) driving signal output
67	T3	O	A.4G	FL tube segment 4G(pin no.8) driving signal output
68	T2	O	A.3G	FL tube segment 3G(pin no.7) driving signal output
69	T1	O	A.2G	FL tube segment 2G(pin no.6) driving signal output
70	T0	O	A.1G	FL tube segment 1G(pin no.5) driving signal output
71	Vfdp			FL pre-driver POWER SUPPLY (-30V)
72	Vdd			Microprocessor POWER input (+5V)
73	NC		NC	Unused pull up (+15V)
74	PG0	O	LED	STAND BY LED drive output
75	PG1	C	POWER	POWER RELAY control signal output
76	PG2	O	F. RELAY	FRONT RELAY control signal output
77	PG3	O	C/S. RELAY	CENTER/SURROUND control signal output
78	PE0/EO0/INT0	I	SEL. CW	Input of ROTARY ENCODER PHASE A signal output for INPUT SELECTOR
79	PE1/EC1/INT1	I	SEL. CCW	Input of ROTARY ENCODER PHASE B signal output for INPUT SELECTOR
80	PE2/IN2	I	VOL. CW	Input of ROTARY ENCODER PHASE A signal output for VOLUME

ADJUSTMENT

ADJUSTMENT

No.	ITEM	INPUT SETTINGS	OUTPUT SETTINGS	AMPLIFIER SETTING	ALIGNMENT POINTS	ALIGN FOR	FIG
Unless otherwise specified, set the respective switches as follows: POWER : ON SELECTOR : CD (NO SIGNAL) SURROUND : PRO LOGIC							
1	IDLE CURRENT	—	Connect a DC voltmeter across CP1 (L) CP2 (R) CP3 (C) CP4 (S) (X09-)	VOLUME: 0	VR1 (L) VR2 (R) (X09-) VR3 (C) VR4 (S) (X09-)	13.2mV 10mV-13.2mV	(a)
2	PRO LOGIC S-OUT NOISE LEVEL	Short CN11 (X11-) (B/5) Short CN10 (X11-) (E/5)	Connect a oscilloscope Rear sp L or R. (Connect load with Rear sp L and R.)	Volume : MAX REAR LEVEL : MAX	VR3 (X11-) (E/5)	Minimum noise level (fig. © point of (b)).	(b)

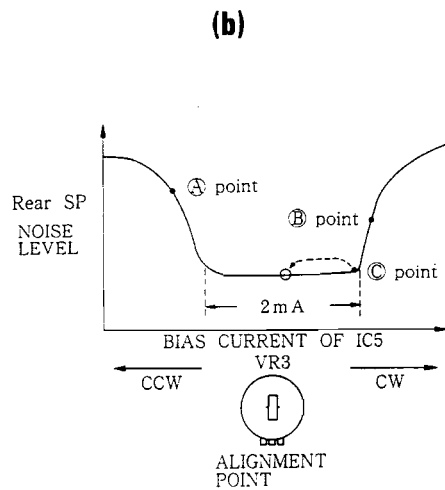
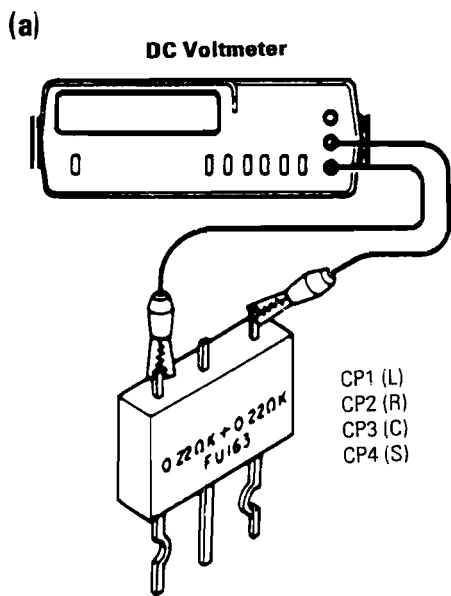

[Procedure]

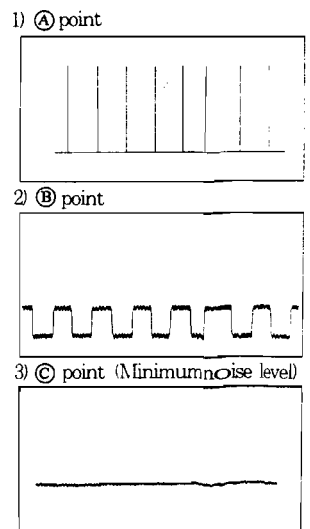

WIRING DIAGRAM

MODEL NAME	PRODUCT. P.	DESTINATION		AUDIO UNIT	CONTROL UNIT
		COUNTRY	ABB		
KA-894	SINGAPORE MADE	U.S.A.	K	X09-3960-10	X11-3500-11
		MEXICO	R	X09-3961-01	
		CANADA	P	X09-3960-21	
		GENERAL MARKET	M	X09-3962-91	
		PX	Y	X09-3960-71	
		AUSTRALIA	X	X09-3960-10	
KA-994	SINGAPORE MADE	U.S.A.	K	X09-3970-10	X11-3500-10
		MEXICO	R	X09-3971-01	
		CANADA	P	X09-3970-21	
		GENERAL MARKET	M	X09-3972-91	
KA-V3700	FRANCE MADE	PX	Y	X09-3970-71	X11-3502-71
		AUSTRALIA	X	X09-3970-10	
		U.S.A.	K	X09-3970-10	
		MEXICO	R	X09-3971-01	
KA-994	MALAYSIA MADE	CANADA	P	X09-3971-01	X11-3502-71
		CANADA	P	X09-3971-01	
KA-V3700	FRANCE MADE	U.K.	T	X09-3960-51	X11-3502-71
		EUROPE	E	X09-3962-71	

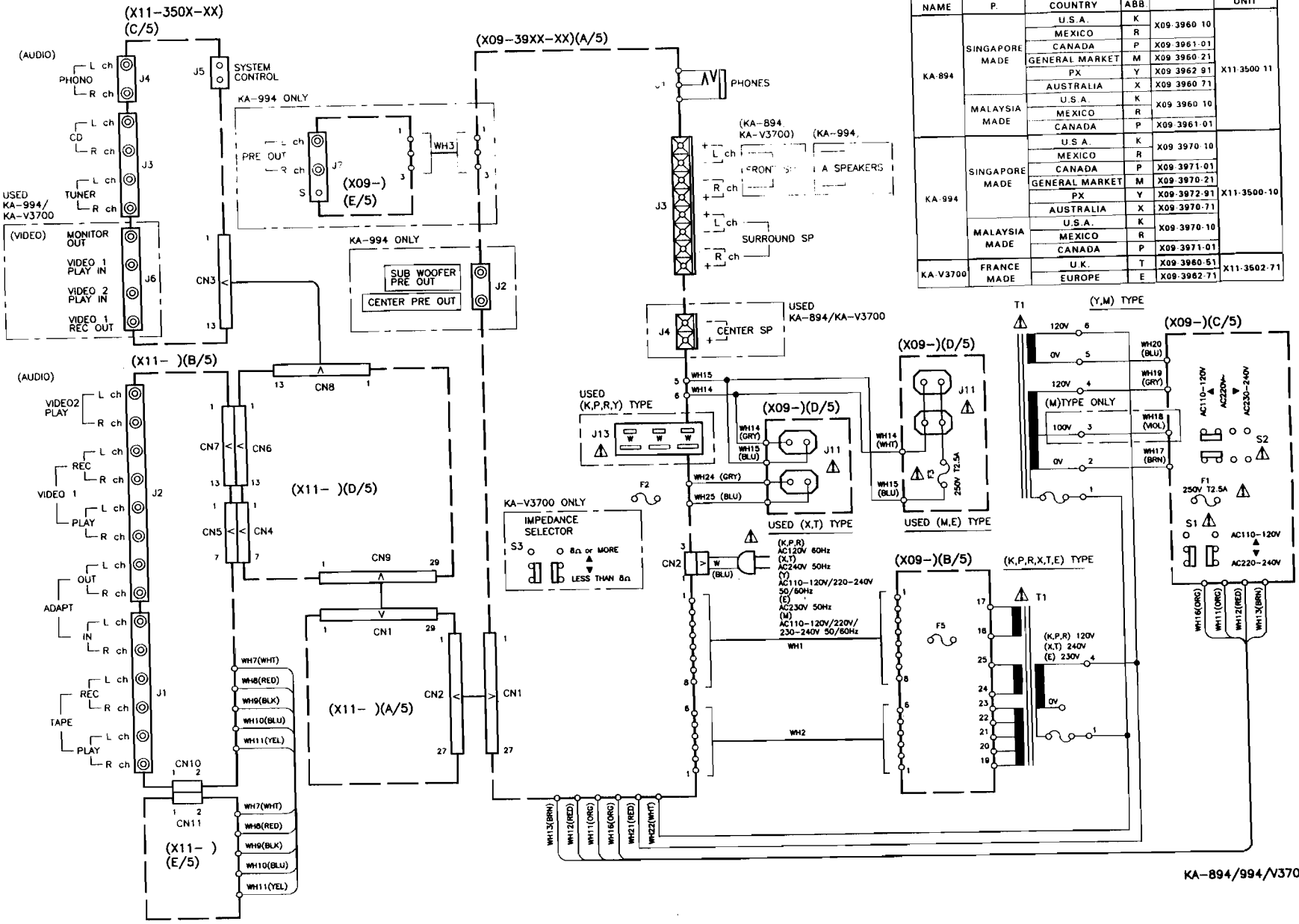

KA-894/994/V3700

PC BOARD (COMPONENT SIDE VIEW)

CONTROL UNIT

X11-350X-XX C/5

(KA-894:0-11, 994:0-10, V3700:2-71)

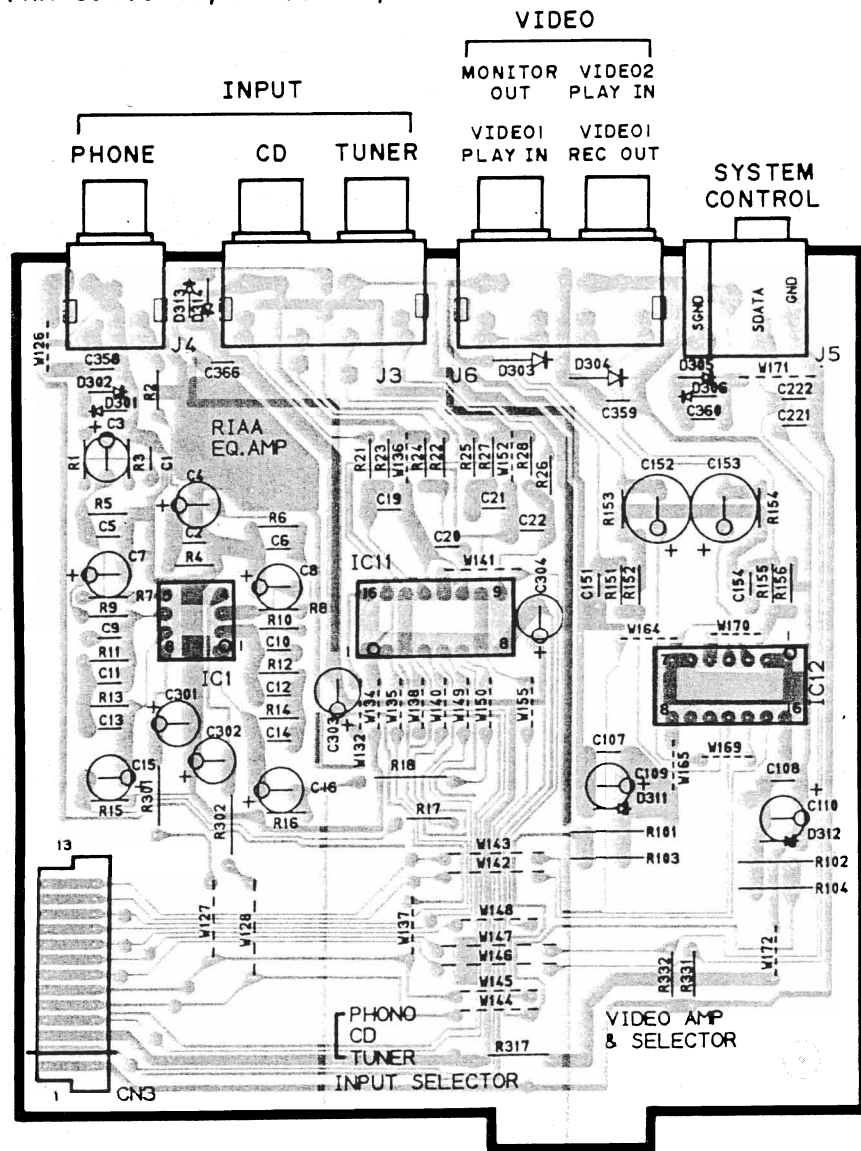

X11- E/5

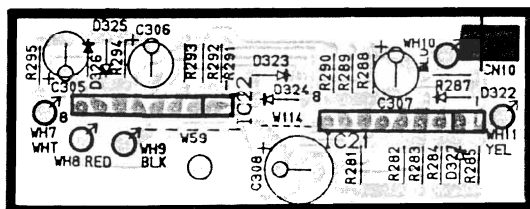

X11- D/5

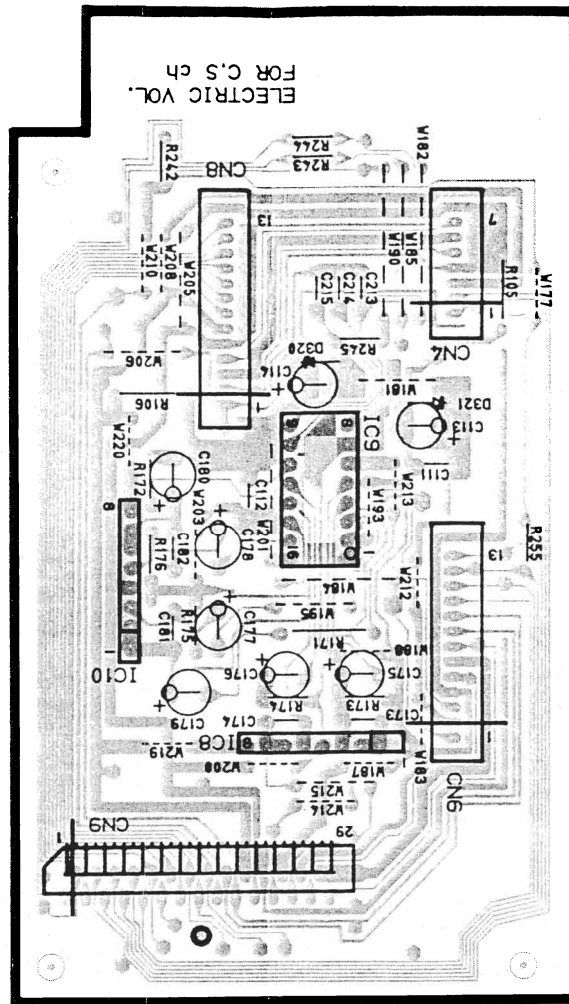

X11- B/5

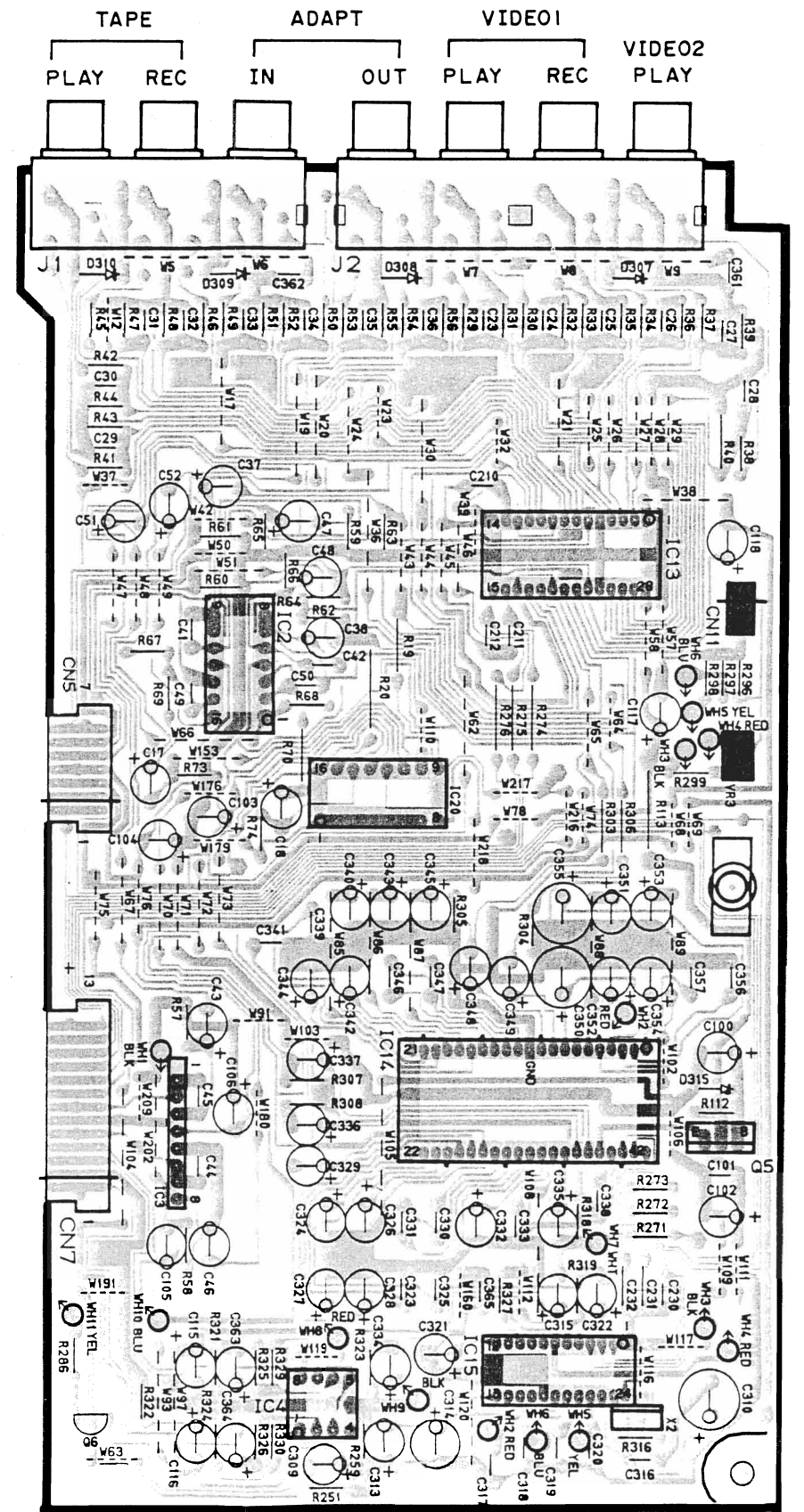

PC BOARD (COMPONENT SIDE VIEW)

CONTROL UNIT

X11-350X-XX A/5 (

- 71)

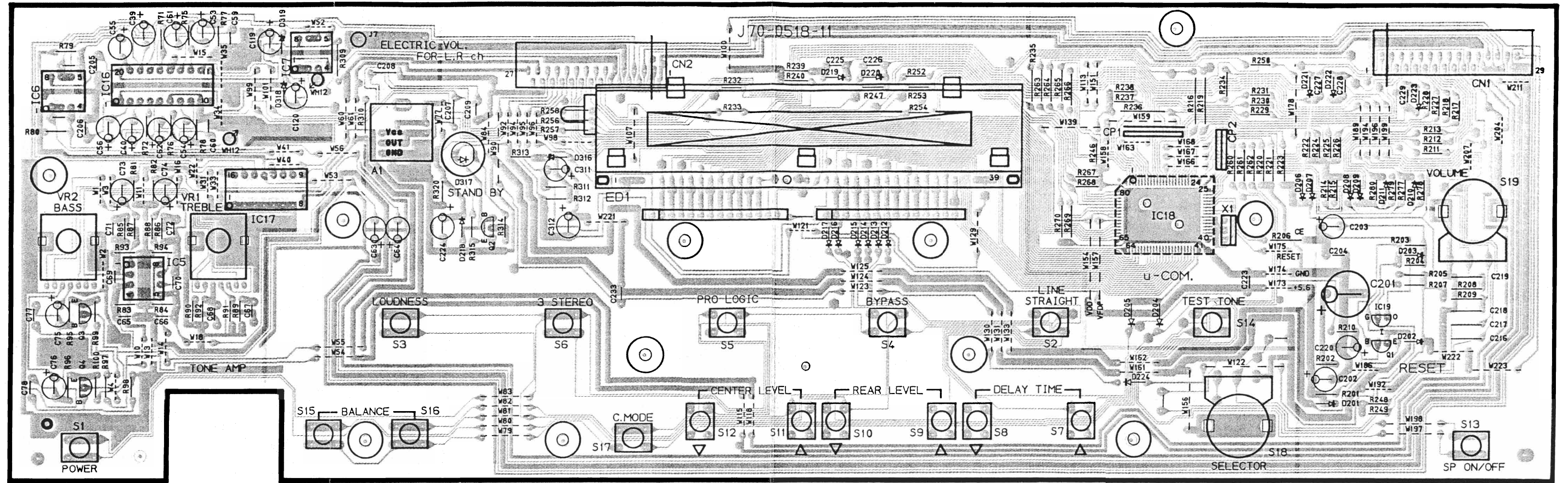

PC BOARD (COMPONENT SIDE VIEW) AUDIO UNIT

DC voltmeter

(a) IDLE CURRENT
 (CP1,2) : 13.2mV
 (CP3,4) : 10mV ~ 13.2mV

Oscilloscope

(2) PRO LOGIC
 S-OUT NOISE LEVEL :
 Minimum noise level

X09-396X-XX C/5
 (KA-894 : 0-10 , V3700 : 2-71)

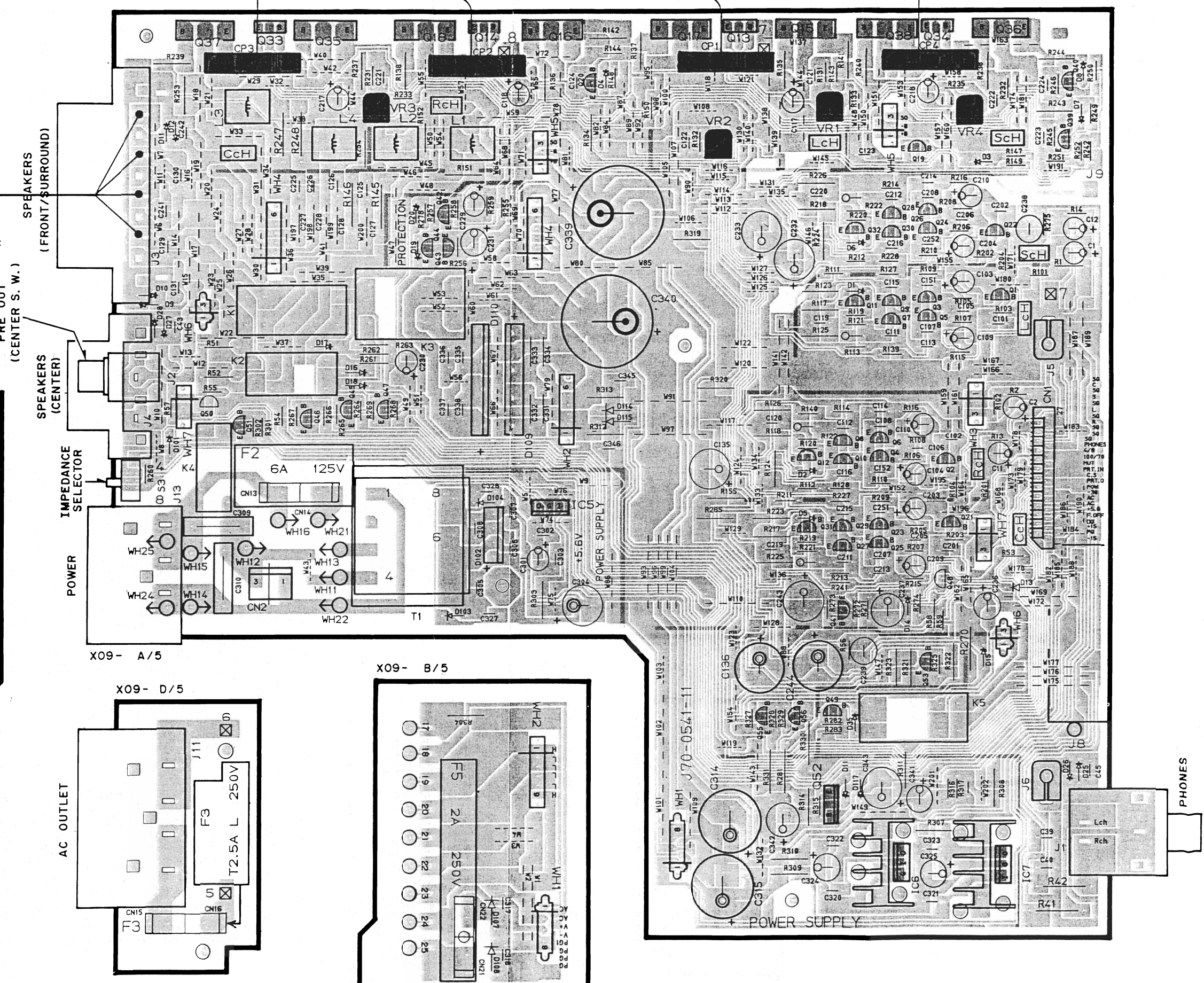
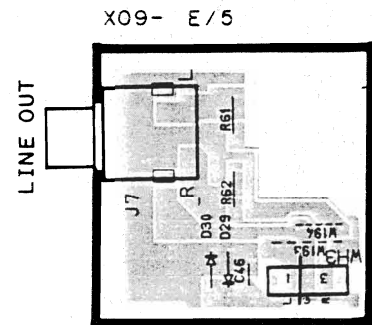
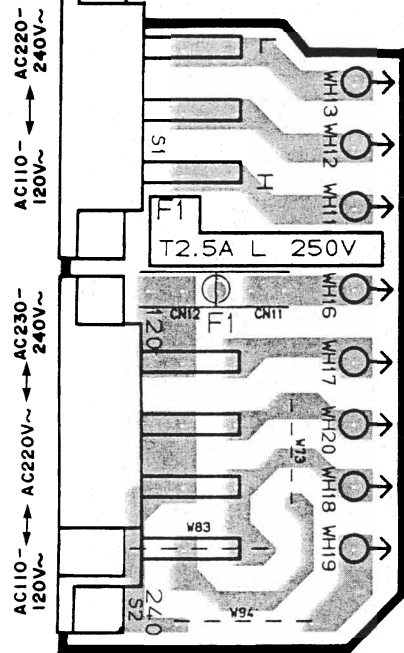

X09- A/5

X09- B/5

X09- D/5

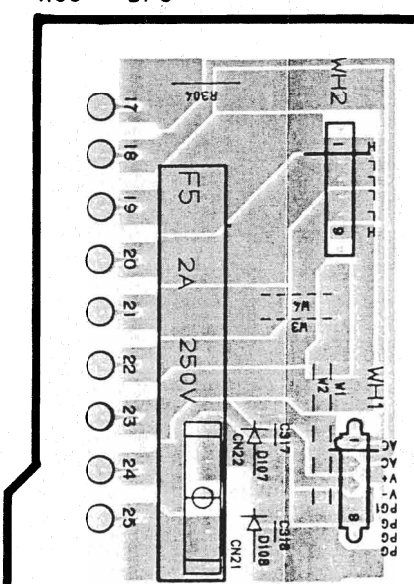
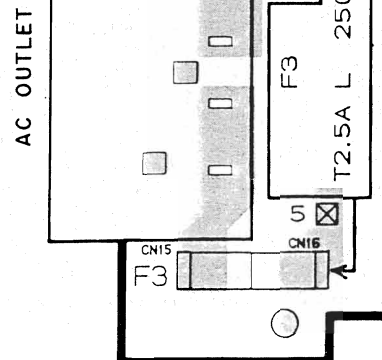

PC BOARD (COMPONENT SIDE VIEW) AUDIO UNIT

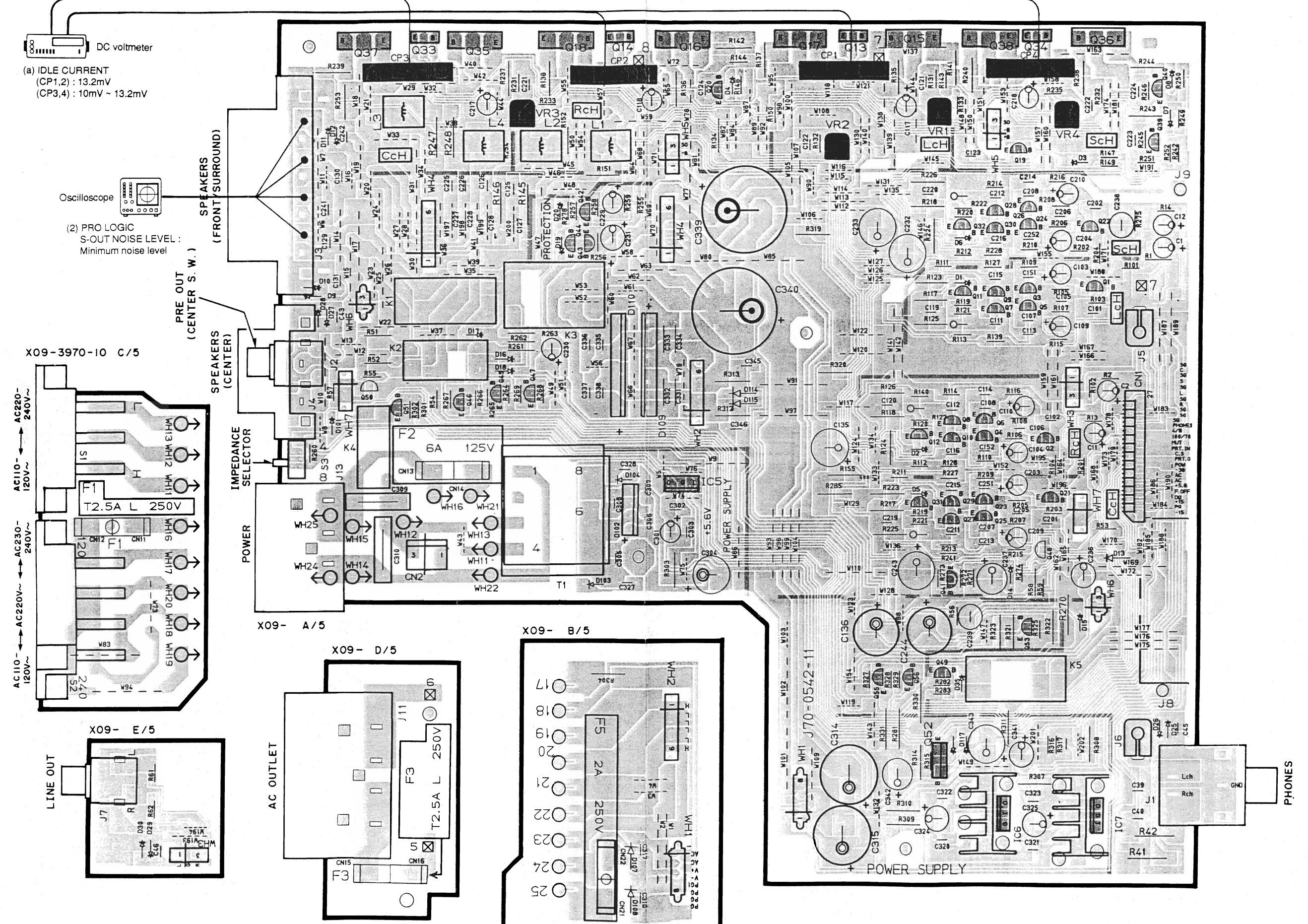

(a) IDLE CURRENT
 (CP1,2) : 13.2mV
 (CP3,4) : 10mV ~ 13.2mV

Oscilloscope

(2) PRO LOGIC
 S-OUT NOISE LEVEL :
 Minimum noise level

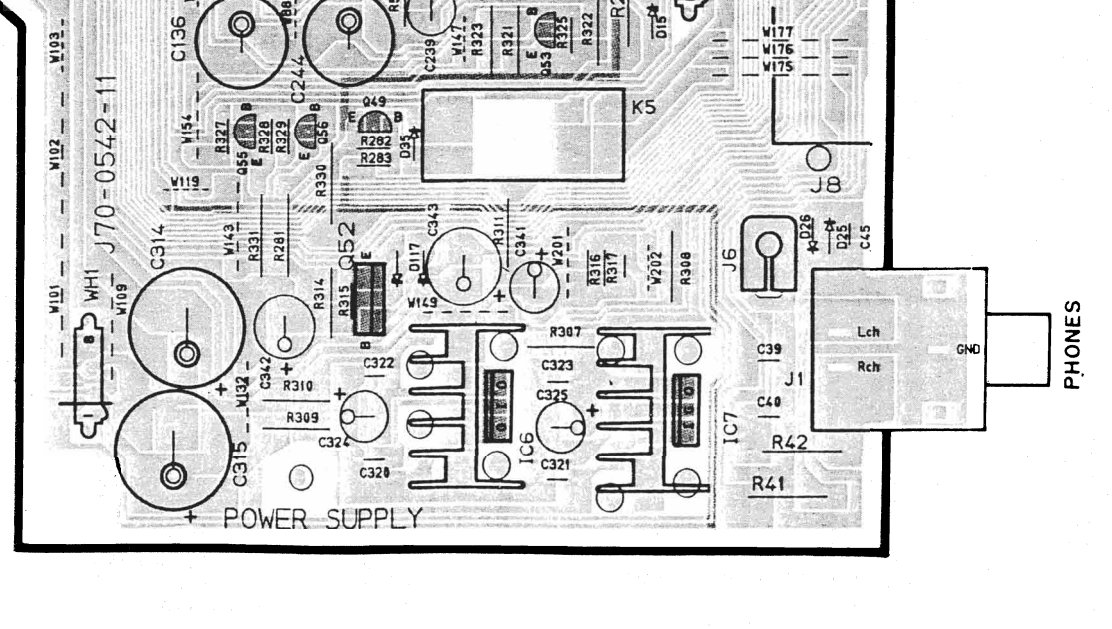
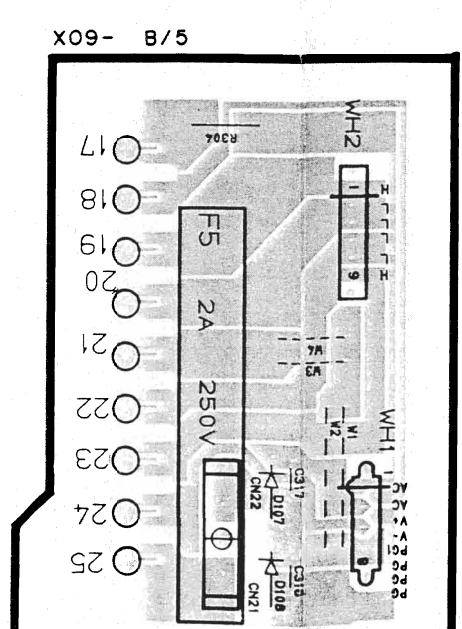
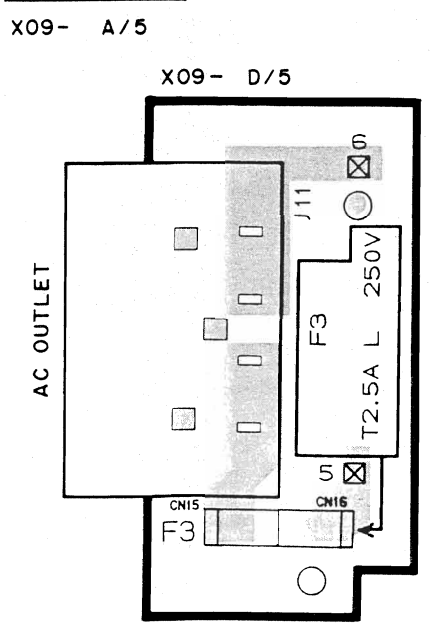
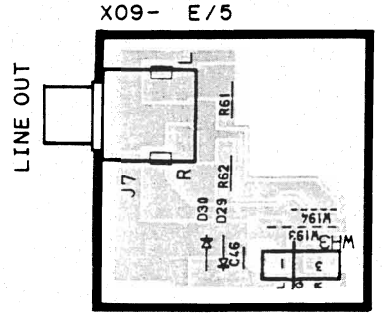
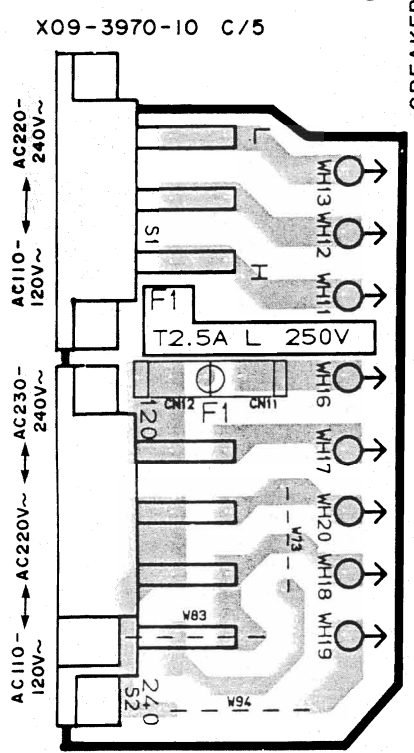

(X11-350X-XX) (A/5)



ANODE CONNECTION

	1G	2G	3G	4G	5G	6G	7G	8G	9G	10G	11G
a	a	a	a	a	a	a	a	a	a	a	a
b	b	b	b	b	b	b	b	b	b	b	b
c	c	c	c	c	c	c	c	c	c	c	c
d	d	d	d	d	d	d	d	d	d	d	d
e	e	e	e	e	e	e	e	e	e	e	e
f	f	f	f	f	f	f	f	f	f	f	f
g	g	g	g	g	g	g	g	g	g	g	g
h	h	h	h	h	h	h	h	h	h	h	h
i	i	i	i	i	i	i	i	i	i	i	i
j	j	j	j	j	j	j	j	j	j	j	j
k	k	k	k	k	k	k	k	k	k	k	k
m	LOUDNESS	LINE STRAIGHT	k	k	k	k	k	k	k	k	k
n	MUTING TAPE2	m	m	m	m	m	m	m	m	m	m
p	3 STEREO	V1	n	n	n	n	n	n	n	n	n
r	SURROUND	V2	p	p	p	p	p	p	p	p	p
s	S	dB	r	r	r	r	r	r	r	r	r
t											

MODEL NAME	UNIT NAME	C69.70	D204	D205
KA-994	X11-3500-10	NO	YES	YES
KA-894	X11-3500-11	NO	NO	NO
KA-V3700	X11-3502-71	YES	YES	NO

- IC5-7 : NJM4558D
- IC16 : TC9212P
- IC17 : TC9215P
- IC18 : CXP82320-162Q
- IC19 : S-80740AL
- Q1-4 : 2SC1740S(Q,R) or 2SC2785(F,E)
- D201-224 : 1SS133 or HSS104
- D316 : RD5.6ES(B2) or HZS5.6N(B2)
- D317 : B30-2461-05
- D318,319 : RD13ES(B2) or HZS13N(B2)
- A1 : W02-1174-05/W02-1188-05/W02-1046-05
- ED1 : FIP11SM8R

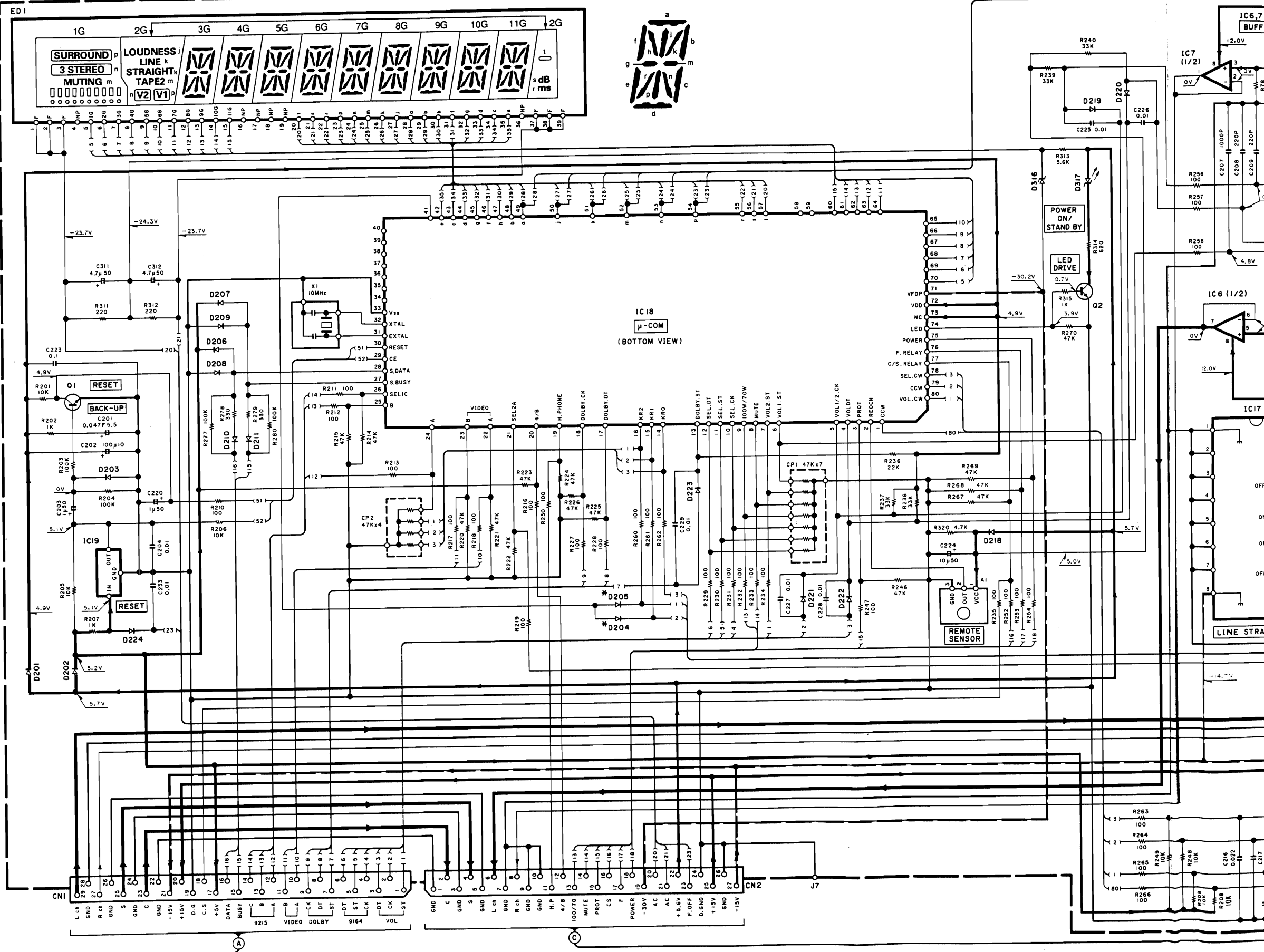
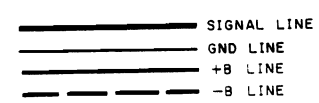

X11-D/5 -CN9



(A)

(C)

OFF
ON
ON
OFF

LINE STRAI

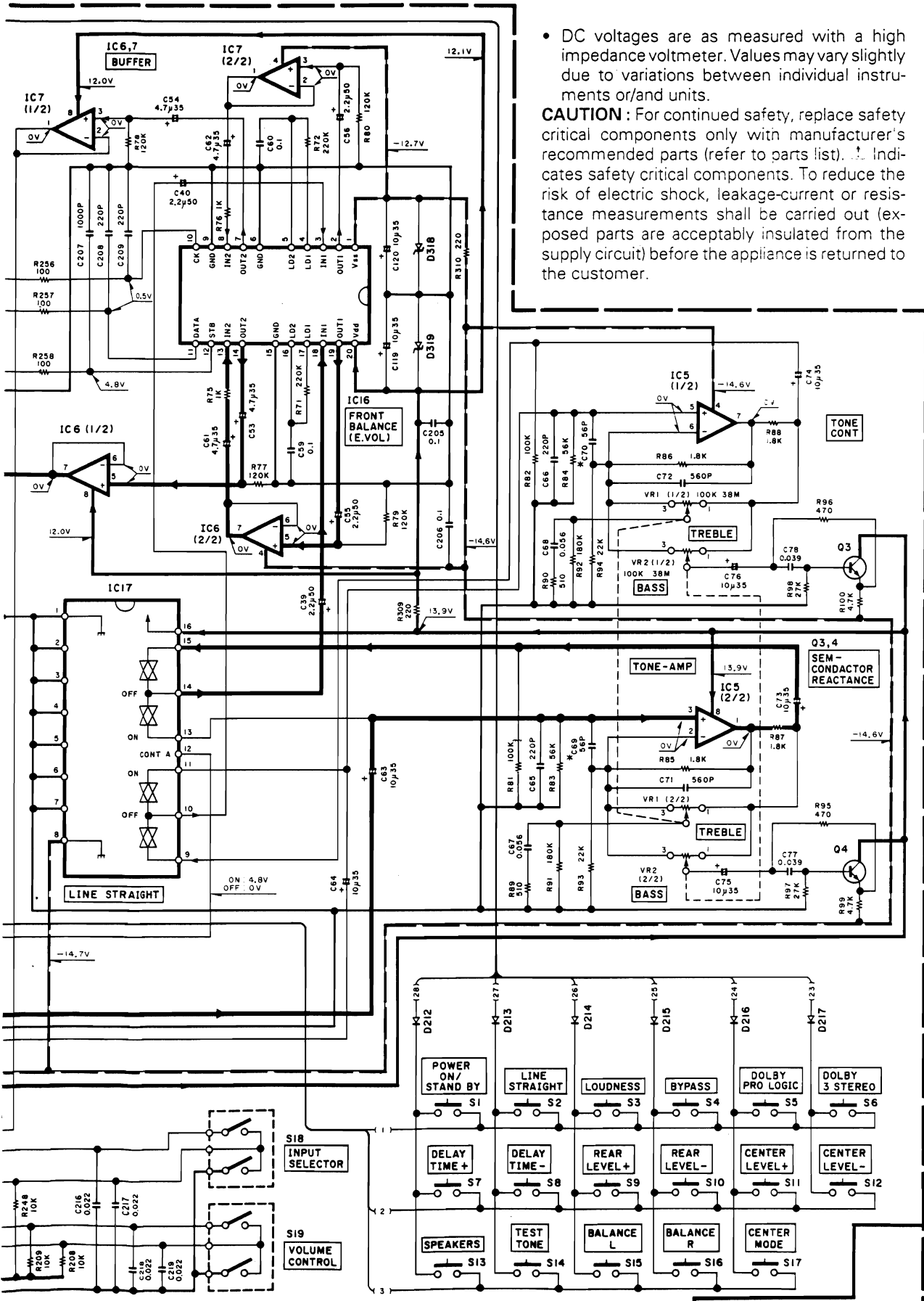

• DC voltages are as measured with a high impedance voltmeter. Values may vary slightly due to variations between individual instruments or/and units.

CAUTION: For continued safety, replace safety critical components only with manufacturer's recommended parts (refer to parts list). ⚡ Indicates safety critical components. To reduce the risk of electric shock, leakage-current or resistance measurements shall be carried out (exposed parts are acceptably insulated from the supply circuit) before the appliance is returned to the customer.

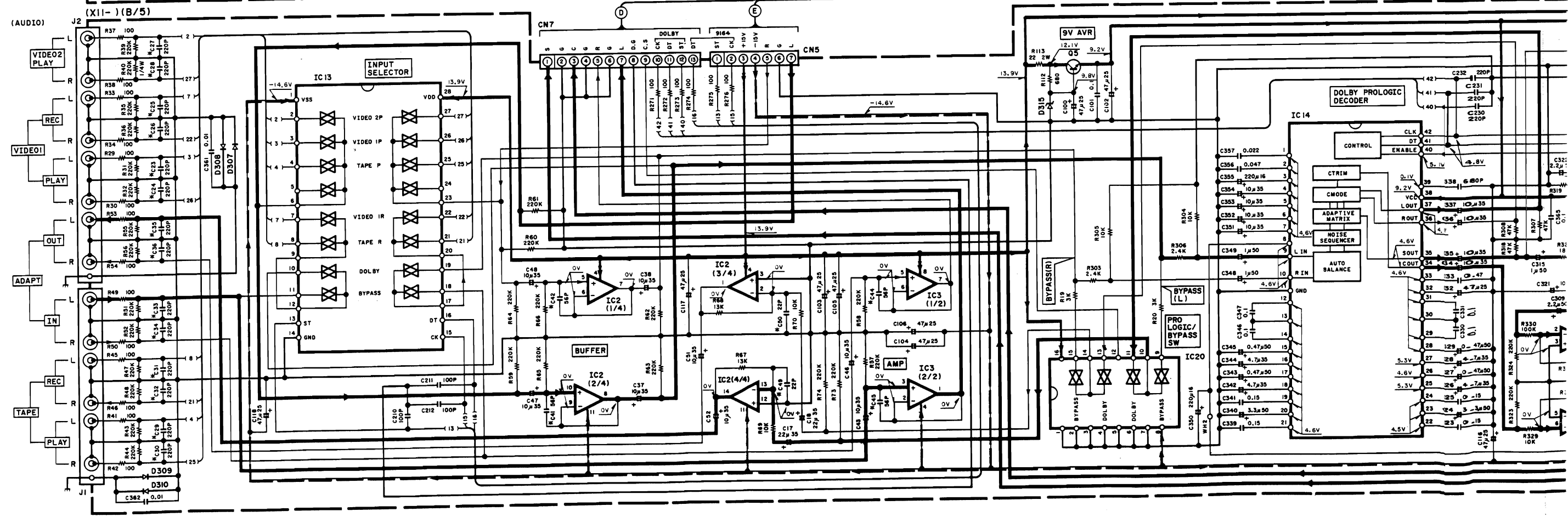
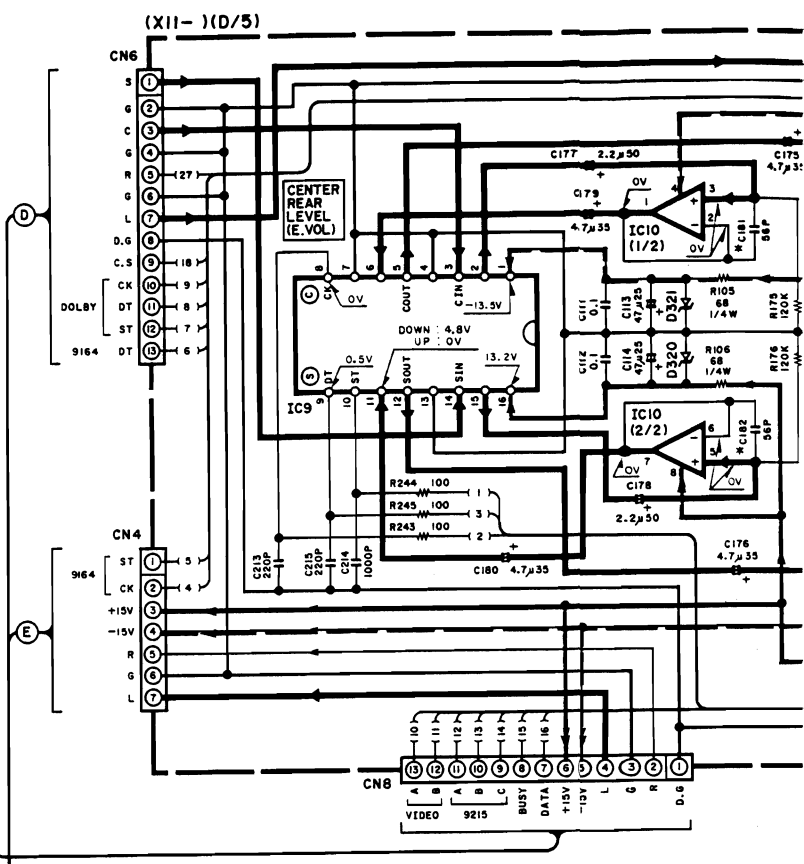
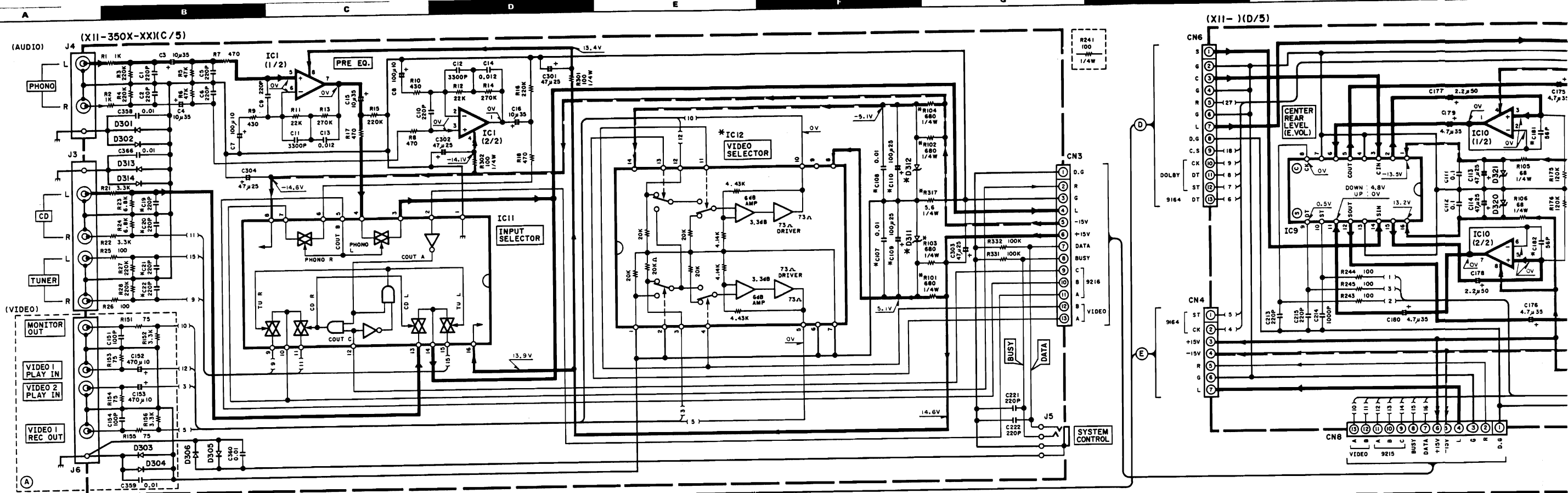

• DC voltages are as measured with a high impedance voltmeter. Values may vary slightly due to variations between individual instruments or/and units

CAUTION : For continued safety, replace safety critical components only with manufacturer's original parts. * Indicates safety critical components. To reduce the risk of electric shock, leakage current (exposed parts are acceptably insulated from the supply circuit) before the appliance is re

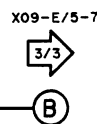
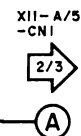
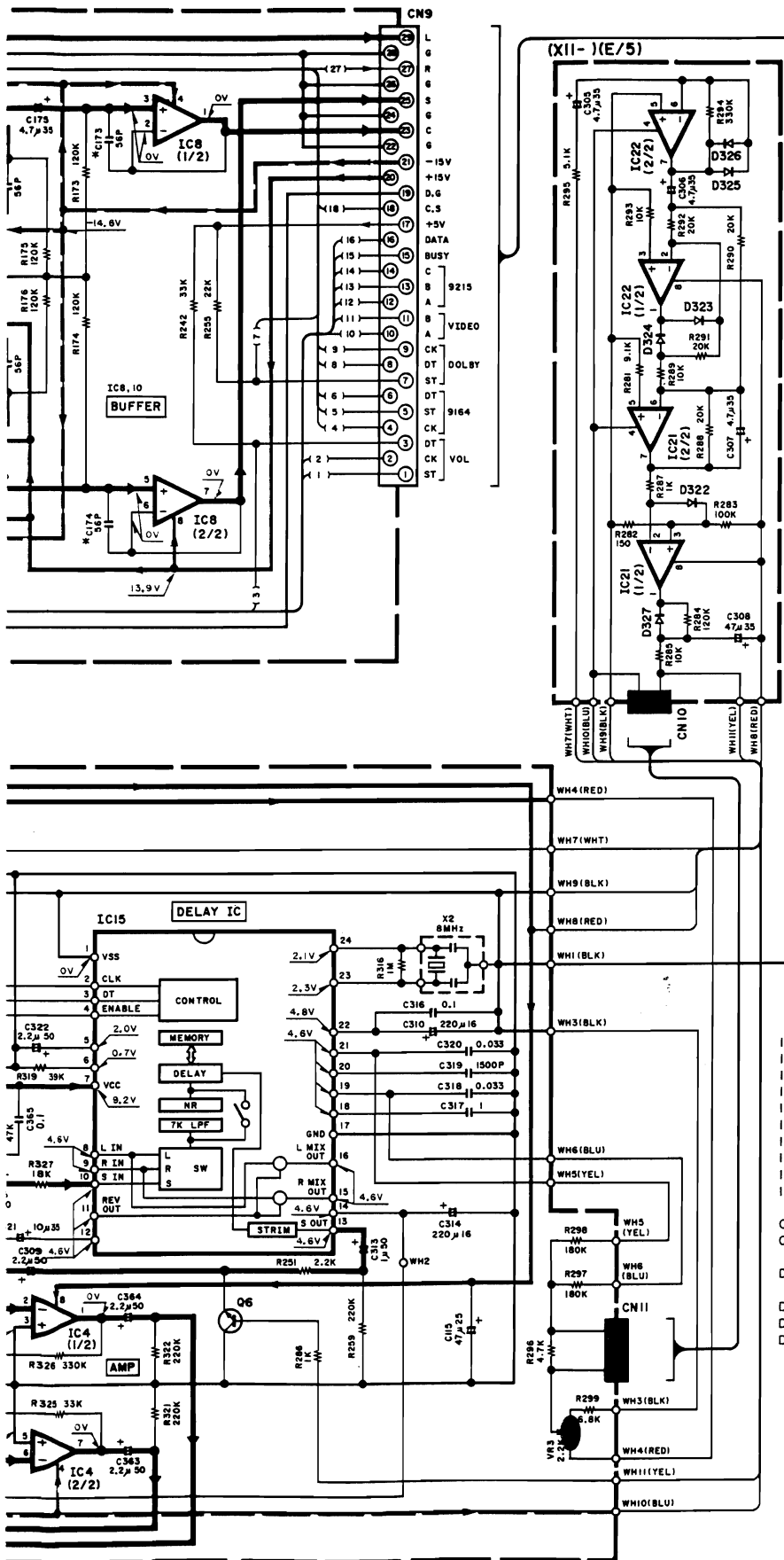

- IC1 : NJM4580-D
- IC2 : NJM2058D
- IC3,8,10,21,22 : NJM4580L
- IC4 : NJM4558D
- IC9 : TC9213P
- IC11,20 : TC9215P
- IC12 : NJM2279D
- IC13 : NJU7313L or TC9164N
- IC14 : LA2785
- IC15 : LV1010

- Q5 : 2SD2061(E,F) or 2SC2012
- Q6 : 2SC2878(B)

- D301-310,313,314,322-327 : 1SS133 or HSS104
- D311,312 : RD5.1ES(B2) or HZS5.1N(B2)
- D315 : RD10ES(B2) or HZS10N(B2)
- D320,321 : RD13ES(B2) or HZS13N(B2)

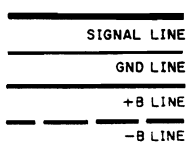

KA-894/994/V3700(K)(1/3)

Manufacturer's recommended parts (refer to parts current or resistance measurements shall be carried out and returned to the customer.

Y08-5030-10

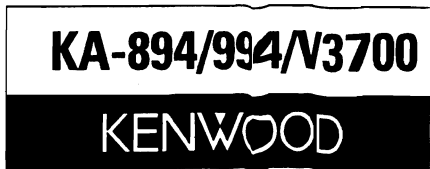

(X09-396X-XX) KA-894 / KA-V3700, (X09-397X-XX) KA-994 (A/5)

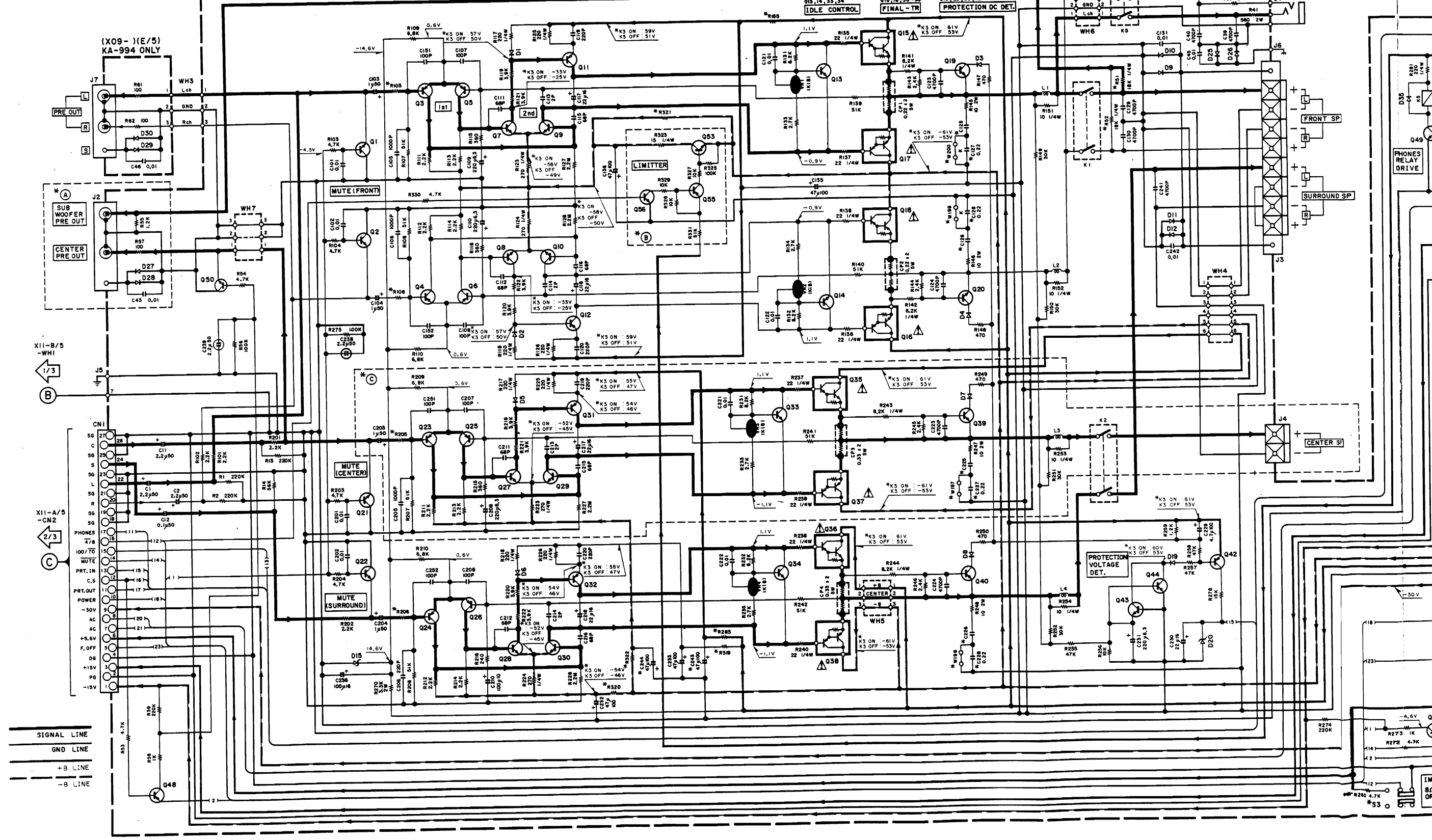

(X09-) (E/5)
KA-994 ONLY

SUB
WOOFER
PRE OUT

X11-B/5
-WH1
1/3

X11-A/5
-CN2
2/3

SIGNAL LINE
GND LINE
+B LINE
-B LINE

• DC voltages are as measured with a high impedance units

A0

AP

AQ

AR

AS

AT

AU

AV

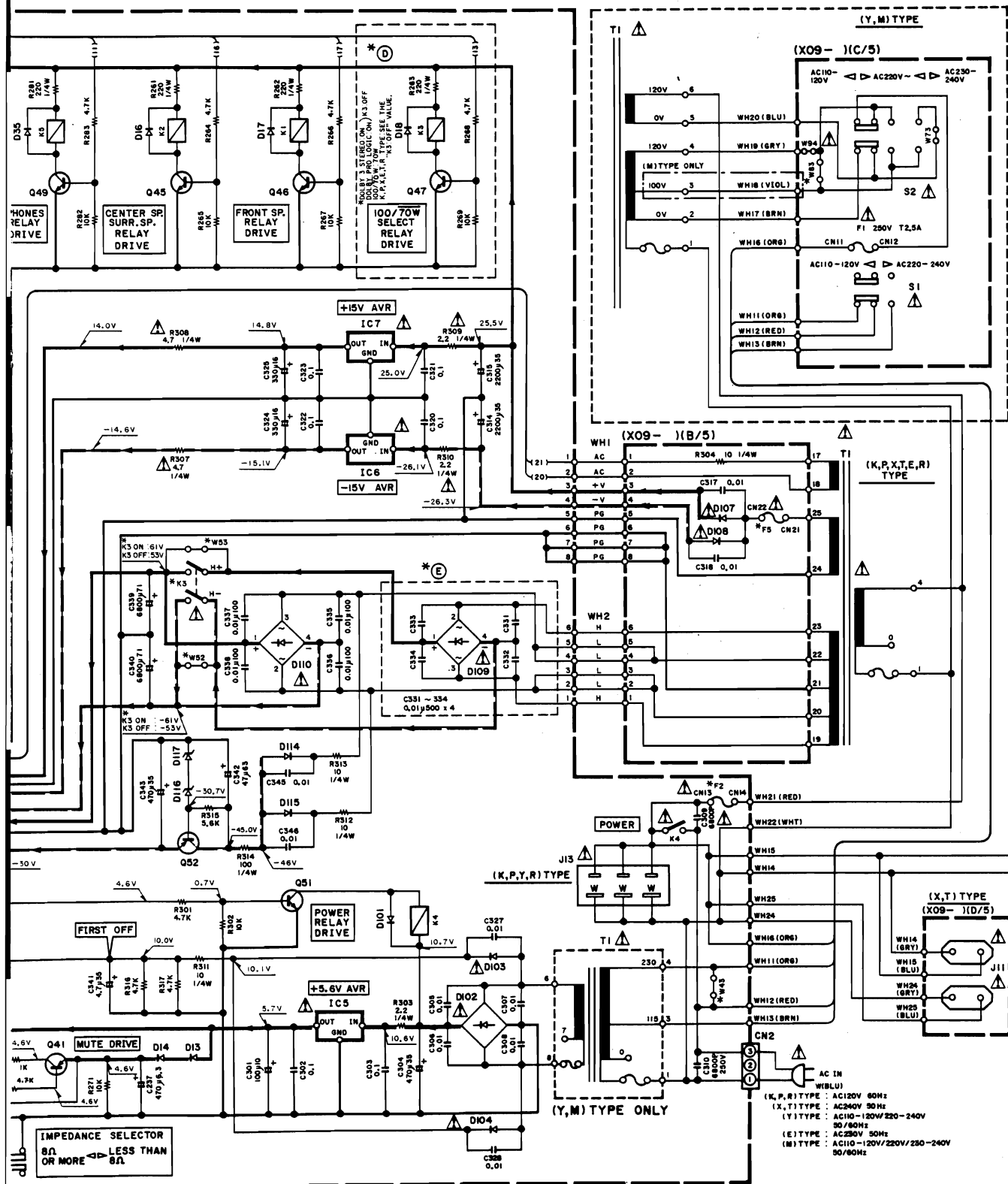

MODEL NAME	PRODUCT P.	DESTINATION COUNTRY	ABB.	UNIT NAME	C125.126.225.226	C127.128.227.228	C243.244	R51-53.58.59	R105.106.205.206	R155	R800	R285.322	R319.320	R321	R323.330	
KA-894	SINGAPORE MADE	U.S.A.	K	X09-3960-10	0.1	NO	YES	NO	100	150 1/4W	YES	820 1/4W	560 1/4W	150 1/4W	NO	
		MEXICO	R	X09-3960-10												
		CANADA	P	X09-3961-01												
		GENERAL MARKET	M	X09-3960-21	0.22	YES	YES	NO	100	150 1/4W	YES	820 1/4W	560 1/4W	150 1/4W	NO	
KA-V3700	MALAYSIA MADE	U.S.A.	K	X09-3960-10	0.1	NO	YES	NO	100	150 1/4W	YES	820 1/4W	560 1/4W	150 1/4W	NO	
		MEXICO	R	X09-3960-10												
		CANADA	P	X09-3961-01												
		EUROPE	E	X09-3962-71	0.22	YES	YES	NO	1K	22 1/4W	YES	1K 1/4W	820 1/4W	1.2K 1/4W	YES	
KA-894	SINGAPORE MADE	U.S.A.	K	X09-3970-10	0.1	NO	NO	YES	100	150 1/4W	NO	NO	820 1/4W	150 1/4W	NO	
		MEXICO	R	X09-3970-10												
		CANADA	P	X09-3971-01												
		GENERAL MARKET	M	X09-3970-21	0.22	YES	NO	YES	100	150 1/4W	NO	NO	820 1/4W	150 1/4W	NO	

MODEL NAME	PRODUCT P.	DESTINATION COUNTRY	ABB.	UNIT NAME	A,F	B	C	D,E	W43	WS2.53	W83	W197-200	K3	S3	F2	F5	Q48	
KA-894	SINGAPORE MADE	U.S.A.	K	X09-3960-10	NO	NO	YES	YES	YES	NO	NO	YES	YES	NO	UL125V6A	UL250V2A	NO	
		MEXICO	R	X09-3960-10														
		CANADA	P	X09-3961-01														
		GENERAL MARKET	M	X09-3960-21	NO	NO	YES	YES	NO	NO	NO	YES	NO	NO	250V T2.5A	250V T2A	NO	
KA-V3700	MALAYSIA MADE	U.S.A.	K	X09-3960-10	NO	NO	YES	YES	YES	NO	NO	YES	YES	NO	UL125V6A	UL250V2A	NO	
		MEXICO	R	X09-3970-10														
		CANADA	P	X09-3961-01														
		EUROPE	E	X09-3962-71	NO	YES	YES	NO	YES	YES	NO	NO	NO	YES	250V T2.5A	250V T2A	NO	
KA-894	SINGAPORE MADE	U.S.A.	K	X09-3970-10	YES	NO	NO	YES	YES	NO	NO	YES	YES	NO	UL125V5A	UL250V2A	YES	
		MEXICO	R	X09-3970-10														
		CANADA	P	X09-3971-01														
		GENERAL MARKET	M	X09-3970-21	YES	NO	NO	YES	NO	NO	NO	NO	YES	NO	250V T2.5A	250V T2A	YES	

LV1010

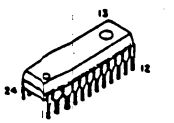

LA2785

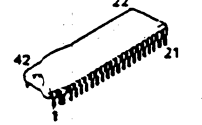

- D1-8,16-19,35,103,104 : 1SS131 or HSS104A
- D9-14,25,26,101 : 1SS133 or HSS104
- D15,116 : RD15ES(B2) or HZS15N(B2)
- D20 : RD4.7ES(B2) or HZS4.7N(B2)
- D102 : KBP02ML-6127
- D107,108,114,115 : S5688B or 1SR139-100
- D109,110 : DSSB20F03 or RBV-602LFA
- D117 : RD16ES(B2) or HZS16N(B2)
- Q1,2,21,22,50 : 2SC2878(B)
- Q3-6,23-26,42,55 : 2SA992(F,E)
- Q7-10 : 2SC2632(R,S)
- Q11,12 : 2SA1124(R,S)
- Q13,14,33,34 : 2SC4137
- Q15,16 : 2SB1594LB
- Q17,18 : 2SD2449LB
- Q19,20,27-30,39 : 2SC2631(R,S)
- Q31,32 : 2SA1123(R,S)
- Q35,36 : 2SD2255BT
- Q37,38 : 2SB1493BT
- Q40,43,44,53,56 : 2SC1845(F,E)
- Q41,48 : 2SA833(O,R) or 2SA1175(F,E)
- Q45-47,49,51 : 2SC2003(L,K)
- Q52 : 2SB1370 or 2SB1375
- IC5 : TA780575
- IC6 : µPC7915HF or TA79015S
- IC7 : µPC7815AHF or TA78155

2SB1370 2SD2061



2SB1375 2SD2012



2SB1594LB 2SD2449LB

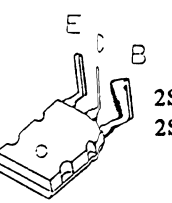

NJM4558D

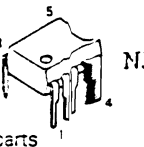

KA-894/994/V3700(K)(3/3)

high impedance voltmeter. Values may vary slightly due to variations between individual instruments

CAUTION : For continued safety, replace safety critical components only with manufacturer's recommended parts (refer to parts list). Indicates safety critical components. To reduce the risk of electric shock, leakage-current or resistance measurements shall be carried out (exposed parts are acceptably insulated from the supply circuit) before the appliance is returned to the customer.

KA894/994/V3700

EXPLODED VIEW (UNIT)

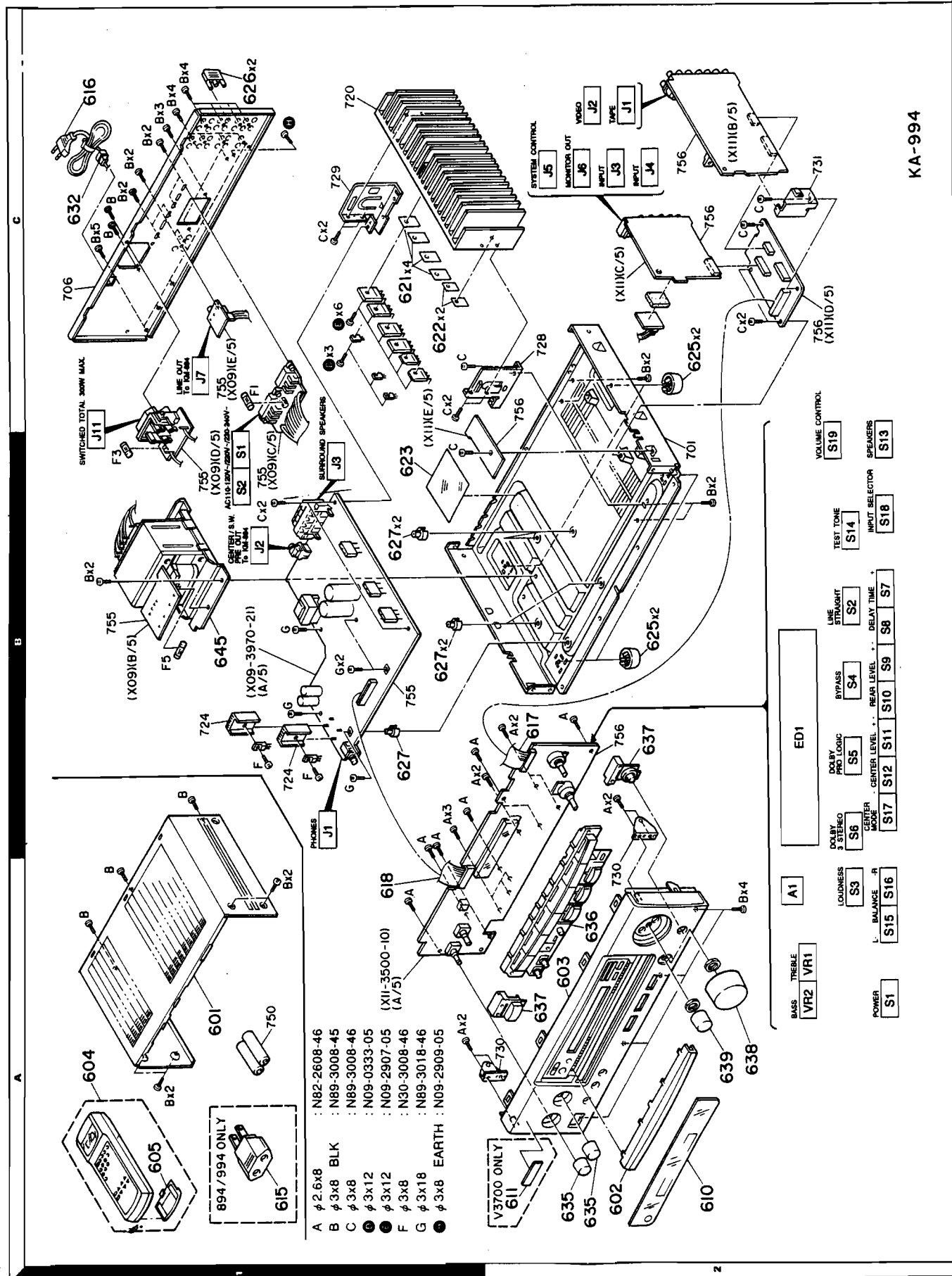

KA-994

PARTS LIST

* New Parts
Parts without Parts No. are not supplied.
Les articles non mentionnés dans le Parts No. ne sont pas fournis.
Teile ohne Parts No. werden nicht geliefert.

* New Parts
Parts without Parts No. are not supplied.
Les articles non mentionnés dans le Parts No. ne sont pas fournis.
Teile ohne Parts No. werden nicht geliefert.

Ref. No. 参照番号	Address 位置	New Parts 新部品	Parts No. 部品番号	Description 部品名/規格	Desti- nation 向標	Re- marks 備考
KA-894 (SINGAPORE MADE)						
H	1C		N08-0128-35	BINDING POST (EARTH)		
601	1A	*	A01-3098-11	METALLIC CABINET		
602	2A	*	A21-1855-03	DRESSING PANEL		
603	2A	*	A60-0540-11	PANEL		
604	1A	*	A70-0974-05	REMOTE CONTROLLER ASY RC-S0800		
605	1A	*	A09-0170-08	BATTERY COVER		
610	2A	*	B03-2890-23	DRESSING PLATE		K
-	-	-	B46-0092-33	WARRANTY CARD		Y
-	-	-	B46-0094-03	WARRANTY CARD		Y
-	-	-	B46-0095-03	WARRANTY CARD		Y
-	-	-	B46-0096-43	WARRANTY CARD		X
-	-	-	B46-0121-33	WARRANTY CARD (PRESET220-240)		P
-	-	-	B58-0513-04	CAUTION CARD		Y
-	-	-	B58-0964-03	CAUTION CARD UL		KYR
-	-	-	B58-0965-03	CAUTION CARD PL (PTX TYPE)		PX
-	-	-	B58-0966-03	CAUTION CARD PL (ELM TYPE)		M
-	-	-	B58-0970-03	CAUTION CARD PL (R TYPE)		R
-	-	-	B60-1504-00	INSTRUCTION MANUAL (EN)		P
-	-	-	B60-1505-00	INSTRUCTION MANUAL (F)		MR
-	-	-	B60-1506-00	INSTRUCTION MANUAL (SP)		M
-	-	-	B60-1507-00	INSTRUCTION MANUAL (C)		M
615	1A	*	E03-0115-05	AC PLUG ADAPTER		M
616	1C	*	E30-2592-15	AC POWER CORD		M
616	1C	*	E30-2605-05	AC POWER CORD		Y
616	1C	*	E30-2650-05	AC POWER CORD		KPR
616	1C	*	E30-2717-05	AC POWER CORD		X
617	2B	*	E35-0766-05	FLAT CABLE 29P X11 CN1-X11 CN9		X
618	1A	*	E35-0767-05	FLAT CABLE 27P X11 CN2-X09 CN1		
J11	1C	*	E03-0141-05	AC OUTLET		
621	1C	*	F20-1284-05	INSULATING BOARD		MX
622	1C	*	F20-1297-05	INSULATING SHEET		
623	1B	*	F20-1393-04	INSULATING SHEET		
624	2C	*	G10-0173-04	CUSHION		
625	2B, 2C	*	H50-0961-04	ITEM CARTON CASE		KPYXR
626	1C	*	H50-0966-04	ITEM CARTON CASE		M
627	1B	*	H10-5876-02	POLYSTYRENE FOAMED FIXTURE (L)		
627	1C	*	H10-5877-02	POLYSTYRENE FOAMED FIXTURE (R)		
632	1C	*	H13-0147-14	CARTON BOARD		X
635	2A	*	H25-0232-04	PROTECTION BAG (235X350X0.03)		
636	2A	*	H25-1516-04	PROTECTION BAG		
637	2A, 2B	*	J02-0366-15	FOOT		
638	2A, 2B	*	J12-0091-15	PIN		
639	2A	*	J19-3657-14	UNIT HOLDER		
645	1B	*	J42-0083-05	POWER CORD BUSHING		
645	1B	*	J61-0307-05	WIRE BAND		
645	1A, 2B	*	K29-5838-04	KNOB (BASS/TREBLE)		
645	1A, 1C	*	K29-5849-02	KNOB (SURROUND)		
645	1C, 2C	*	K29-5850-03	KNOB (POWER/SPEAKERS)		
645	1C	*	K29-5851-04	KNOB (VOLUME CONTROL)		
645	1C	*	K29-5866-04	KNOB (INPUT SELECTOR)		
645	1B	*	L07-0876-05	POWER TRANSFORMER		
645	1B	*	L07-0877-05	POWER TRANSFORMER		
A	1A, 2B	*	N82-2608-46	BINDING HEAD TAPRITE SCREW		
B	1A, 1C	*	N89-3008-45	BINDING HEAD TAPRITE SCREW		
C	1C, 2C	*	N89-3008-46	BINDING HEAD TAPRITE SCREW		
D	1C, 2C	*	N09-0333-05	HEXAGON HD TAPPING SCREW M3X12		
E	1C	*	N09-2907-05	TAP SCREW WITH WASHER M3X14		
	**	*	(N87-JV14-V)	BINDING HEAD TAPRITE SCREW		

Ref. No. 参照番号	Address 位置	New Parts 新部品	Parts No. 部品番号	Description 部品名/規格	Desti- nation 向標	Re- marks 備考
KA-V3700 (FRANCE MADE)						
601	1A	*	A01-3098-11	METALLIC CABINET		
602	2A	*	A21-1855-03	DRESSING PANEL		
603	2A	*	A60-0541-21	PANEL		
604	1A	*	A70-0974-05	REMOTE CONTROLLER ASY RC-S0800		
605	1A	*	A09-0170-08	BATTERY COVER		
610	2A	*	B03-2890-23	DRESSING PLATE		T
-	-	-	B43-0287-04	KENWOOD BADGE		T
-	-	-	B46-0310-03	WARRANTY CARD		
-	-	-	B58-0945-03	CAUTION CARD		
-	-	-	B58-0965-03	CAUTION CARD PL (PTX TYPE)		
-	-	-	B58-0966-03	CAUTION CARD PL (ELM TYPE)		
-	-	-	B60-1508-00	INSTRUCTION MANUAL (EN)		E
-	-	-	B60-1509-00	INSTRUCTION MANUAL (F/G/D/I)		E
616	1C	*	E30-2592-15	AC POWER CORD		E
617	1C	*	E30-2721-05	AC POWER CORD		T
618	1A	*	E35-0766-05	FLAT CABLE 29P X11 CN1-X11 CN9		
J11	1C	*	E03-0085-05	AC OUTLET		T
621	1C	*	F20-1284-05	INSULATING BOARD		
622	1C	*	F20-1297-05	INSULATING SHEET		
623	1B	*	F20-1393-04	INSULATING SHEET		
624	2C	*	F20-1258-04	INSULATING BOARD		
624	2C	*	G10-0173-04	CUSHION		
625	2B, 2C	*	H50-0968-04	ITEM CARTON CASE		T
626	1C	*	H50-0999-04	ITEM CARTON CASE		E
627	1B	*	H10-5738-02	POLYSTYRENE FOAMED FIXTURE (L)		
627	1C	*	H10-5739-02	POLYSTYRENE FOAMED FIXTURE (R)		
632	1C	*	H11-0057-04	POLYSTYRENE FOAMED BOARD		T
635	2A	*	H13-0149-04	CARTON BOARD		
636	2A	*	H25-0232-04	PROTECTION BAG (235X350X0.03)		T
637	2A	*	H25-0361-04	PROTECTION BAG		E
638	2A	*	H25-0651-04	PROTECTION BAG (0232 PRINTED)		E
639	2A	*	H25-0666-04	PROTECTION BAG (0361 PRINTED)		T
625	2B, 2C	*	J02-1040-05	FOOT		
626	1C	*	J12-0091-15	PIN		
627	1B	*	J19-3657-14	UNIT HOLDER		
632	1C	*	J42-0083-05	POWER CORD BUSHING		
632	1C	*	J61-0307-05	WIRE BAND		
635	2A	*	K29-5838-04	KNOB (BASS/TREBLE)		
636	2A	*	K29-5849-02	KNOB (SURROUND)		
637	2A, 2B	*	K29-5850-03	KNOB (POWER/SPEAKERS)		
638	2A	*	K29-5851-04	KNOB (VOLUME CONTROL)		
639	2A	*	K29-5866-04	KNOB (INPUT SELECTOR)		
645	1B	*	L07-0876-05	POWER TRANSFORMER		E
645	1B	*	L07-0877-05	POWER TRANSFORMER		T
A	1A, 2B	*	N82-2608-46	BINDING HEAD TAPRITE SCREW		
B	1A, 1C	*	N89-3008-45	BINDING HEAD TAPRITE SCREW		
C	1C, 2C	*	N89-3008-46	BINDING HEAD TAPRITE SCREW		
D	1C, 2C	*	N09-0333-05	HEXAGON HD TAPPING SCREW M3X12		
E	1C	*	N09-2907-05	TAP SCREW WITH WASHER M3X14		
	**	*	(N87-JV14-V)	BINDING HEAD TAPRITE SCREW		

L:Scandinavia K:USA P:Canada R:Mexico
Y:PX(Far East, Hawaii) T:England E:Europe
X:Australia M:Other Areas

△ indicates safety critical components

PARTS LIST

* New Parts
Parts without Parts No. are not supplied.
Les articles non mentionnés dans le Parts No. ne sont pas fournis.
Teile ohne Parts No. werden nicht geliefert.

Ref. No. 参照番号	Address 位置	New Parts 新部品番号	Parts No. 部品番号	Description 部品名 / 規格	Desti- nation 仕向備考	Re- marks 備考
D	1C		N09-0333-05	HEXAGON HD TAPPING SCREW M3X12		
E	1C		N09-2907-05	TAP SCREW WITH WASHER M3X14		
G	1B		N89-3018-46	BINDING HEAD TAPPIE SCREW		
H	1C		N09-2909-05	TAPPIE SCREW (EARTH)		
KA-994 (SINGAPORE MADE)						
601	1A	*	A01-3098-11	METALLIC CABINET		
602	2A	*	A21-1855-03	DRESSING PANEL		
603	2A	*	A60-0539-11	PANEL		
604	1A	*	A70-0978-05	REMOTE CONTROLLER ASY RC-R0801		
605	1A	*	A09-0169-08	BATTERY COVER		
610	2A	*	B03-2890-23	DRESSING PLATE		K
-	-	-	B46-0092-33	WARRANTY CARD		Y
-	-	-	B46-0094-03	WARRANTY CARD		Y
-	-	-	B46-0095-03	WARRANTY CARD		Y
-	-	-	B46-0096-43	WARRANTY CARD		X
-	-	-	B46-0121-33	WARRANTY CARD		P
-	-	-	B58-0513-04	CAUTION CARD (PRESET220-240)		P
-	-	-	B58-0964-03	CAUTION CARD UL (PTX TYPE)		KYR
-	-	-	B58-0965-03	CAUTION CARD PL (ELM TYPE)		DX
-	-	-	B58-0966-03	CAUTION CARD PL (ELM TYPE)		M
-	-	-	B58-0970-03	CAUTION CARD PL (R TYPE)		R
-	-	-	B60-1500-00	INSTRUCTION MANUAL (EN)		P
-	-	-	B60-1501-00	INSTRUCTION MANUAL (F)		MR
-	-	-	B60-1502-00	INSTRUCTION MANUAL (SP)		M
-	-	-	B60-1503-00	INSTRUCTION MANUAL (C)		M
-	-	-	B60-1595-00	I/MANUAL PRESET RC (EN)		P
-	-	-	B60-1596-00	I/MANUAL PRESET RC (F)		MR
-	-	-	B60-1597-00	I/MANUAL PRESET RC (SP)		M
-	-	-	B60-1598-00	I/MANUAL PRESET RC (C)		M
615	1A		E03-0115-05	AC PLUG ADAPTER		M
616	1C		E30-2592-15	AC POWER CORD		M
616	1C		E30-2605-05	AC POWER CORD		M
616	1C		E30-2650-05	AC POWER CORD		KPR
616	1C		E30-2717-05	AC POWER CORD		X
617	2B	*	E35-0766-05	FLAT CABLE 29P X11 CN1-X11 CN9		X
618	1A	*	E35-0767-05	FLAT CABLE 27P X11 CN2-X09 CN1		X
J11	1C		E03-0141-05	AC OUTLET		
621	1C		F20-1284-05	INSULATING BOARD		MX
622	1C		F20-1297-05	INSULATING SHEET		
623	1B	*	F20-1393-04	INSULATING SHEET		
624	2C		G10-0173-04	CUSHION		
-	-	-	H50-0958-04	ITEM CARTON CASE		KPYXR
-	-	-	H50-0959-04	ITEM CARTON CASE		M
-	-	-	H10-5676-02	POLYSTYRENE FOAMED FIXTURE (L)		
-	-	-	H10-5677-02	POLYSTYRENE FOAMED FIXTURE (R)		
-	-	-	H13-0147-14	CARTON BOARD		X
-	-	-	H25-0232-04	PROTECTION BAG (235X350X0.03)		
-	-	-	H25-1516-04	PROTECTION BAG		
625	2B, 2C		I02-0366-15	FOOT		
626	1C		J12-0091-15	PIN		
627	1C		J19-3657-14	UNIT HOLDER		
632	1B	*	J42-0083-05	POWER CORD BUSHING		
632	1C	*	J61-0307-05	WIRE BAND		
635	2A	*	K29-5838-04	KNOB (BASS/TREBLE)		
636	2A	*	K29-5849-02	KNOB (SURROUND)		
637	2A, 2B	*	K29-5850-03	KNOB (POWER/SPEAKERS)		
638	2A	*	K29-5851-04	KNOB (VOLUME CONTROL)		
639	2A	*	K29-5866-04	KNOB (INPUT SELECTOR)		
645	1B		L07-0843-05	POWER TRANSFORMER		P
645	1B		L07-0847-05	POWER TRANSFORMER		KR
645	1C, 2C		N09-0333-05	BINDING HEAD TAPPIE SCREW		
645	1C, 2C		N09-2907-05	BINDING HEAD TAPPIE SCREW		
645	1C, 2C		N09-3018-46	BINDING HEAD TAPPIE SCREW		
645	1C, 2C		N09-2909-05	TAPPIE SCREW (EARTH)		

* New Parts
Parts without Parts No. are not supplied.
Les articles non mentionnés dans le Parts No. ne sont pas fournis.
Teile ohne Parts No. werden nicht geliefert.

Ref. No. 参照番号	Address 位置	New Parts 新部品番号	Parts No. 部品番号	Description 部品名 / 規格	Desti- nation 仕向備考	Re- marks 備考
645	1B		L07-0845-05	POWER TRANSFORMER	X	
645	1B	*	L07-0846-05	POWER TRANSFORMER	Y	
645	1B	*	L07-0847-05	POWER TRANSFORMER	KR	
A	1A, 2B		N82-2608-46	BINDING HEAD TAPPIE SCREW	M	
B	1A, 1C		N89-3008-45	BINDING HEAD TAPPIE SCREW		
C	1C, 2C		N89-3008-46	BINDING HEAD TAPPIE SCREW		
D	1C		N09-0333-05	HEXAGON HD TAPPING SCREW M3X12		
E	1C		N09-2907-05	TAP SCREW WITH WASHER M3X14		
G	1B		N89-3018-46	BINDING HEAD TAPPIE SCREW		
H	1C		N09-2909-05	TAPPIE SCREW (EARTH)		
KA-894 (MALAYSIA MADE)						
601	1A	*	A01-3098-11	METALLIC CABINET		
602	2A	*	A21-1855-03	DRESSING PANEL		
603	2A	*	A60-0540-11	PANEL		
604	1A	*	A70-0978-05	REMOTE CONTROLLER ASY RC-S0800		
605	1A	*	A09-0170-08	BATTERY COVER		
610	2A	*	B03-2890-23	DRESSING PLATE		K
-	-	-	B46-0092-33	WARRANTY CARD		P
-	-	-	B46-0121-33	WARRANTY CARD		KR
-	-	-	B58-0964-03	CAUTION CARD UL (PTX TYPE)		P
-	-	-	B58-0965-03	CAUTION CARD PL (R TYPE)		R
-	-	-	B58-0970-03	CAUTION CARD PL (R TYPE)		R
-	-	-	B60-1504-00	INSTRUCTION MANUAL (EN)		P
-	-	-	B60-1505-00	INSTRUCTION MANUAL (F)		P
-	-	-	B60-1506-00	INSTRUCTION MANUAL (SP)		R
616	1C		E30-2650-05	AC POWER CORD		
617	2B	*	E35-0766-05	FLAT CABLE 29P X11 CN1-X11 CN9		
618	1A	*	E35-0767-05	FLAT CABLE 27P X11 CN2-X09 CN1		
621	1C		F20-1284-05	INSULATING BOARD		
622	1C		F20-1297-05	INSULATING SHEET		
624	2C		G10-0173-04	CUSHION		
-	-	-	H50-0997-04	ITEM CARTON CASE		
-	-	-	H10-5680-02	POLYSTYRENE FOAMED FIXTURE (L)		
-	-	-	H10-5681-02	POLYSTYRENE FOAMED FIXTURE (R)		
-	-	-	H25-0232-04	PROTECTION BAG (235X350X0.03)		
-	-	-	H25-1516-04	PROTECTION BAG		
625	2B, 2C		J02-0366-15	FOOT		
626	1C		J12-0091-15	PIN		
627	1C	*	J19-3657-14	UNIT HOLDER		
632	1B	*	J42-0083-05	POWER CORD BUSHING		
632	1C	*	J61-0307-05	WIRE BAND		
635	2A	*	K29-5838-04	KNOB (BASS/TREBLE)		
636	2A	*	K29-5849-02	KNOB (SURROUND)		
637	2A, 2B	*	K29-5850-03	KNOB (POWER/SPEAKERS)		
638	2A	*	K29-5851-04	KNOB (VOLUME CONTROL)		
639	2A	*	K29-5866-04	KNOB (INPUT SELECTOR)		
645	1B		L07-0843-05	POWER TRANSFORMER		P
645	1B		L07-0847-05	POWER TRANSFORMER		KR
645	1C, 2C		N09-0333-05	BINDING HEAD TAPPIE SCREW		
645	1C, 2C		N09-2907-05	BINDING HEAD TAPPIE SCREW		
645	1C, 2C		N09-3008-45	BINDING HEAD TAPPIE SCREW		
645	1C, 2C		N09-3008-46	BINDING HEAD TAPPIE SCREW		

L:Scandinavia
Y:PX(Far East, Hawaii)
Y:AFES(Europe)

K:USA
T:England
X:Australia

P:Canada
E:Europe
M:Other Areas

R:Mexico

△ indicates safety critical components

PARTS LIST

1 New Parts
Parts without Parts No. are not supplied
Les articles non mentionnés dans le Parts No. ne sont pas fournis
Teil ohne Parts No. werden nicht geliefert.

Ref. No. 参照番号	Address 位置	New Parts 新部品	Parts No. 部品番号	Description 部品名 / 規格	Desti- nation 向	Re- marks 備考
635	2A	*	K29-5838-04	KN0B (BASS/TREBLE)		
636	2A	*	K29-5849-02	KN0B (SURROUND)		
637	2A, 2B	*	K29-5850-03	KN0B (POWER/SPEAKERS)		
638	2A	*	K29-5851-04	KN0B (VOLUME CONTROL)		
639	2A	*	K29-5866-04	KN0B (INPUT SELECTOR)		
645	1B	*	L07-0871-05	POWER TRANSFORMER	KR	
645	1B	*	L07-0872-05	POWER TRANSFORMER	P	
645	1B	*	L07-0873-05	POWER TRANSFORMER	M	
645	1B	*	L07-0874-05	POWER TRANSFORMER	X	
645	1B	*	L07-0875-05	POWER TRANSFORMER	Y	
A	1A, 2B		N82-2608-46	BINDING HEAD TAPITITE SCREW		
B	1A, 1C		N89-3008-45	BINDING HEAD TAPITITE SCREW		
C	1C, 2C		N89-3008-45	BINDING HEAD TAPITITE SCREW		
D	1C		N09-0333-05	HEXAGON HD TAPPING SCREW M3X12		
E	1C		N09-2907-05	TAP SCREW WITH WASHER H3X14		
G	1B		N89-3018-46	BINDING HEAD TAPITITE SCREW		
H	1C		N09-2909-05	TAPITITE SCREW (EARTH)		
KA-894 (MALAYSIA MADE)						
601	1A	*	A01-3098-11	METALLIC CABINET		
602	2A	*	A21-1855-03	DRESSING PANEL		
603	2A	*	A60-0539-11	PANEL		
604	1A	*	A70-0961-05	REMOTE CONTROLLER ASY RC-R0801		
605	1A	*	A09-0169-08	BATTERY COVER		
610	2A	*	B03-2890-23	DRESSING PLATE	K	
-	-	-	B46-6092-33	WARRANTY CARD	P	
-	-	-	B46-0121-33	WARRANTY CARD	K	
-	-	-	B58-0964-03	CAUTION CARD	KR	
-	-	-	B58-0965-03	CAUTION CARD UL (PTX TYPE)	P	
-	-	-	B58-0970-03	CAUTION CARD PL (R TYPE)	K	
-	-	-	B60-1500-00	INSTRUCTION MANUAL (EN)		
-	-	-	B60-1501-00	INSTRUCTION MANUAL (F)		
-	-	-	B60-1502-00	INSTRUCTION MANUAL (SP)	P	
-	-	-	B60-1595-00	I/MANUAL PRESET RC (EN)	R	
-	-	-	B60-1596-00	I/MANUAL PRESET RC (F)	P	
-	-	-	B60-1597-00	I/MANUAL PRESET RC (SP)	R	
616	1C	*	E30-0650-05	AC POWER CORD		
617	2B	*	E35-0768-05	FLAT CABLE 2XP X11 CN1-X11 CN9		
618	1A	*	E35-0767-05	FLAT CABLE 2TP X11 CN2-X09 CN1		
621	1C	*	F20-1284-05	INSULATING BOARD		
622	1C	*	F20-1297-05	INSULATING SHEET		
624	2C	*	G10-0173-04	CUSHION		
-	-	-	H50-0960-04	ITEM CARTON CASE		
-	-	-	H10-5680-02	POLYSTYRENE FOAMED FIXTURE (L)		
-	-	-	H10-5681-02	POLYSTYRENE FOAMED FIXTURE (R)		
-	-	-	H25-0232-04	PROTECTION BAG (235X350X0.03)		
-	-	-	H25-1516-04	PROTECTION BAG		
625	2B, 2C	*	J02-0366-15	FOOT PIN		
626	1C	*	J12-0091-15	UNIL HOLDER		
627	1B	*	J19-3657-14	POWER CORD BUSHING		
632	1C	*	J42-0083-05	WIRE BAND		
-	-	-	J61-0307-05	KN0B (BASS/TREBLE)		
635	2A	*	K29-5838-04	KN0B (BASS/TREBLE)		

* New Parts
Parts without Parts No. are not supplied
Les articles non mentionnés dans le Parts No. ne sont pas fournis
Teil ohne Parts No. werden nicht geliefert.

Ref. No. 参照番号	Address 位置	New Parts 新部品	Parts No. 部品番号	Description 部品名 / 規格	Desti- nation 向	Re- marks 備考
636	2A	*	K29-5849-02	KN0B (SURROUND)		
637	2A, 2B	*	K29-5850-03	KN0B (POWER/SPEAKERS)		
638	2A	*	K29-5851-04	KN0B (VOLUME CONTROL)		
639	2A	*	K29-5866-04	KN0B (INPUT SELECTOR)		
645	1B	*	L07-0871-05	POWER TRANSFORMER	KR	
645	1B	*	L07-0872-05	POWER TRANSFORMER	P	
A	1A, 2B		N82-2608-46	BINDING HEAD TAPITITE SCREW		
B	1A, 1C		N89-3008-45	BINDING HEAD TAPITITE SCREW		
C	1C, 2C		N89-3008-45	BINDING HEAD TAPITITE SCREW		
D	1C		N09-0333-05	HEXAGON HD TAPPING SCREW M3X12		
E	1C		N09-2907-05	TAP SCREW WITH WASHER H3X14		
G	1B		N89-3018-46	BINDING HEAD TAPITITE SCREW		
H	1C		N09-2909-05	TAPITITE SCREW (EARTH)		
KA-894/V3700 AUDIO UNIT (X09-396X-XX)						
C1			CE04LW1H2R2F	ELECTR0		
C11			CE04LW1H2R2M	ELECTR0		
C12			CE04LW1H0R1M	ELECTR0		
C39			CK45FF1H472Z	CERAMIC		
C45			CK45FF1H103Z	CERAMIC		
C101, 102			CK45FF1H103Z	CERAMIC		
C103, 104			CE04LW1H010M	ELECTR0		
C105, 106			C992FM1H102J	MYLAR		
C107, 108			CC45FSL1H101J	CERAMIC		
C109, 110			CE04LW0J221H	ELECTR0		
C111, 112			CC45FSL1H680J	CERAMIC		
C113, 114			CC45FSL1H020C	CERAMIC		
C115, 116			CC45FSL1H680J	CERAMIC		
C117, 118			CE04LW1C220M	ELECTR0		
C119, 120			CC45FSL1H221J	CERAMIC		
C121, 122			CK45FF1H103Z	CERAMIC		
C123, 124			CK45FF1H472Z	CERAMIC		
C125-128			CF92FV1H224J	MF		
C129, 126			CF92FV1H104J	MF		
C129, 130			CK45FF1H472Z	CERAMIC		
C131			CK45FF1H103Z	CERAMIC		
C135, 136			CE04LW2A470M	ELECTR0		
C151, 152			CC45FSL1H101J	CERAMIC		
C201, 202			CK45FF1H103Z	CERAMIC		
C203, 204			CE04LW1H010M	ELECTR0		
C205			C992FM1H102J	MYLAR		
C206			CC45FSL1H221J	CERAMIC		
C207, 208			CC45FSL1H101J	CERAMIC		
C209			CE04LW0J221M	ELECTR0		
C210			CE04LW1A101H	ELECTR0		
C211, 212			CC45FSL1H680J	CERAMIC		
C213, 214			CC45FSL1H020C	CERAMIC		
C215, 216			CC45FSL1H680J	CERAMIC		
C217, 218			CE04LW1C220M	ELECTR0		
C219, 220			CC45FSL1H221J	CERAMIC		
C221, 222			CK45FF1H103Z	CERAMIC		
C223, 224			CK45FF1H472Z	CERAMIC		
C225-228			CF92FV1H224J	MF		
C225, 226			CF92FV1H104J	MF		
C229			CE04LW2A47M	ELECTR0		

* New Parts
Parts without Parts No. are not supplied
Les articles non mentionnés dans le Parts No. ne sont pas fournis
Teil ohne Parts No. werden nicht geliefert.

L:Scandinavia
Y:PX(Far East, Hawaii)
Y:AAFE(S)(Europe)

K:USA
T:England
X:Australia

P:Canada
E:Europe
M:Other Areas

R:Mexico

△ indicates safety critical components.

PARTS LIST

* New Parts
Parts without Parts No. are not supplied
Les articles non mentionnés dans le Parts No. ne sont pas fournis.
Teile ohne Parts No. werden nicht geliefert.



Ref. No. 参照番号	Address 位置	Parts No. 部品番号	Description 部品名/規格	Desti- nation 仕	Re- marks 備考
Q45, 46		25C2003(L,K) 25C2003(L,K) 25C2003(L,K) 25B1370 25B1375	TRANSISTOR TRANSISTOR TRANSISTOR TRANSISTOR TRANSISTOR	TE	
Q53		25C1845(F,E) 25A992(F,E) 25C1845(F,E)	TRANSISTOR TRANSISTOR TRANSISTOR	TE TE TE	
KA-894-AUDIO UNIT (008-3074-00)					
C1, 2		CE04LW1H2R2M ELECTRO	2.2UF 50WV		
C11		CE04LW1H2R2M ELECTRO	2.2UF 50WV		
C12		CE04LW1H0R1M ELECTRO	0.1UF 50WV		
C39, 40		CK45FF1H47Z CERAMIC	4700PF Z		
C43		CK45FF1H103Z CERAMIC	0.010UF Z		
C45, 46		CK45FF1H103Z CERAMIC	0.010UF Z		
C101, 102		CK45FF1H103Z CERAMIC	0.010UF Z		
C103, 104		CE04LW1H10M ELECTRO	1.0UF 50WV		
C105, 106		C92FM1H102J MYLAR	1000PF J		
C107, 108		CC45FSL1H101J CERAMIC	100PF J		
C109, 110		CE04LW0J221M ELECTRO	220UF 6.3WV		
C111, 112		CC45FSL1H60J CERAMIC	68PF J		
C113, 114		CC45FSL1H020C CERAMIC	2.0PF J		
C115, 116		CC45FSL1H680J CERAMIC	88PF J		
C117, 118		CE04LW1C20M ELECTRO	22UF 16WV		
C119, 120		CC45FSL1H221J CERAMIC	220PF J		
C121, 122		CK45FF1H103Z CERAMIC	0.010UF Z		
C123, 124		CK45FF1H47Z CERAMIC	4700PF Z		
C125-128		CF92FV1H224J MF	0.22UF J	YMK	
C125, 126		CF92FV1H104J MF	0.10UF J	KPR	
C129, 130		CK45FF1H47Z CERAMIC	4700PF Z		
C131		CK45FF1H103Z CERAMIC	0.010UF Z		
C135, 136		CE04LW2A470M ELECTRO	47UF 100WV		
C151, 152		CC45FSL1H101J CERAMIC	100PF J		
C201, 202		CK45FF1H103Z CERAMIC	0.010UF Z		
C204		CE04LW1H10M ELECTRO	1.0UF 50WV		
C206		CC45FSL1H221J CERAMIC	220PF J		
C208		CC45FSL1H101J CERAMIC	100PF J		
C210		CE04LW1A10M ELECTRO	100UF 10WV		
C212		CC45FSL1H680J CERAMIC	68PF J		
C214		CC45FSL1H020C CERAMIC	2.0PF C		
C216		CC45FSL1H680J CERAMIC	68PF J		
C218		CE04LW1C20M ELECTRO	22UF 16WV		
C220		CC45FSL1H221J CERAMIC	220PF J		
C222		CK45FF1H103Z CERAMIC	0.010UF Z		
C224		CK45FF1H47Z CERAMIC	4700PF Z		
C226		CF92FV1H104J MF	0.10UF J	KPR	
C228		CF92FV1H224J MF	0.22UF J	YMK	
C229		CF92FV1H224J MF	0.22UF J	YMK	
C230		CE04LW2A47M ELECTRO	4.7UF 100WV		
C231		CE04LW1C20M ELECTRO	22UF 16WV		
C232, 233		CE04LW2A47M ELECTRO	47UF 100WV		
C236		CE04LW1C10M ELECTRO	100UF 16WV		
C237		CE04LW0J471M ELECTRO	470UF 6.3WV		

* New Parts
Parts without Parts No. are not supplied
Les articles non mentionnés dans le Parts No. ne sont pas fournis.
Teile ohne Parts No. werden nicht geliefert.



Ref. No. 参照番号	Address 位置	Parts No. 部品番号	Description 部品名/規格	Desti- nation 仕	Re- marks 備考
D16, 17		ISS131 HSS104A HSS104	DIODE DIODE DIODE	KPYMK KPYMK	
D18		ISS131 HSS104A HSS104	DIODE DIODE DIODE		
D19		ISS131 HSS104A HSS104	DIODE DIODE DIODE		
D20		HZS4.7N(B2) RD4.7ES(B2) HFC104 SS133 HSS104A	ZENER DIODE ZENER DIODE DIODE DIODE DIODE		
D25, 26		ISS131 HSS104A HSS104	DIODE DIODE DIODE		
D35		ISS131 HSS104 HSS104	DIODE DIODE DIODE		
D101		ISS133 KBPO2ML-6127 HSS104A	DIODE DIODE DIODE		
D103, 104		ISS131 S5488B LSR139-100 D5SBA20F03 RBV-602LFA	DIODE DIODE DIODE DIODE DIODE		
D107, 108		D5SBA20F03 RBV-602LFA	DIODE DIODE		
D109, 108		LSR139-100 HZZ15N(B2)	DIODE ZENER DIODE		
D109		RBV-602LFA	DIODE		
D110		D5SBA20F03 RBV-602LFA	DIODE DIODE		
D114, 115		S5688B LSR139-100 HZZ15N(B2)	DIODE DIODE ZENER DIODE		
D116		HZZ15N(B2)	ZENER DIODE		
D116		RD16ES(B2) RD16ES(B2) RD16ES(B2) TA78057S TA79015S	ZENER DIODE ZENER DIODE ZENER DIODE IC(VOLTAGE REGULATOR/ +5.75V) IC(VOLTAGE REGULATOR/ -15V)		
D117		RD16ES(B2)	ZENER DIODE		
D117		RD16ES(B2)	ZENER DIODE		
IC5		TA78057S	IC(VOLTAGE REGULATOR/ +5.75V)		
IC6		TA79015S	IC(VOLTAGE REGULATOR/ -15V)		
IC6		UPC7915HF	IC(VOLTAGE REGULATOR/ -15V)		
IC7		TA7815S	IC(VOLTAGE REGULATOR/ +15V)		
IC7		UPC7815AHF	IC(VOLTAGE REGULATOR/ +15V)		
Q1, 2		25C2878(B) 25A992(F,E)	TRANSISTOR TRANSISTOR		
Q3 -6		25A992(F,E)	TRANSISTOR		
Q7 -10		25C2632(R,S) 25A1124(R,S)	TRANSISTOR TRANSISTOR		
Q13, 14		25C4137 25B1594LB 25D2449LB	TRANSISTOR TRANSISTOR TRANSISTOR		
Q15, 16		25B1594LB 25D2449LB	TRANSISTOR TRANSISTOR		
Q17, 18		25C2631(R,S) 25C2631(R,S)	TRANSISTOR TRANSISTOR		
Q19, 20		25C2631(R,S) 25C2878(B)	TRANSISTOR TRANSISTOR		
Q21, 22		25A992(F,E) 25A992(F,E)	TRANSISTOR TRANSISTOR		
Q23 -26		25C2631(R,S) 25A1123(R,S)	TRANSISTOR TRANSISTOR		
Q27, 30		25C2631(R,S) 25A1123(R,S)	TRANSISTOR TRANSISTOR		
Q31, 32		25A1123(R,S)	TRANSISTOR		
Q33, 34		25C4137 25D2255BT	TRANSISTOR TRANSISTOR		
Q35, 36		25D2255BT 25B1493BT	TRANSISTOR TRANSISTOR		
Q37, 38		25C2631(R,S) 25C1845(F,E)	TRANSISTOR TRANSISTOR		
Q40		25C1845(F,E)	TRANSISTOR		
Q41		25A1175(F,E)	TRANSISTOR		
Q41		25A933S(Q,R)	TRANSISTOR		
Q42		25A992(F,E)	TRANSISTOR		
Q43		25C1845(F,E)	TRANSISTOR		
Q45 -47		25C2003(L,K)	TRANSISTOR		

L:Scandinavia
T:Far East, Hawaii
Y:AFES(Europe)

K:USA
T:England
X:Australia
M:Other Areas

P:Canada
E:Europe

R:Mexico

△ indicates safety critical components.

PARTS LIST

* New Parts
 Parts without Parts No. are not supplied.
 Les articles non mentionnés dans le Parts No. ne sont pas fournis.
 Teile ohne Parts No. werden nicht geliefert.

Ref. No. 参照番号	Address 位置	Parts No. 部品番号	Description 部品名 / 規格	Desti- nation 向	Re- marks 備考
R41, 42		RS14KB3DS61J	FL-PROOF RS 560		
R117, 118		RD14NB2E21J	RD 220		J 2W
R123, 124		RD14NB2E21J	RD 270		J 1/4W
R125, 126		RD14NB2E21J	RD 220		J 1/4W
R135-138		RD14NB2E220J	RD 22		J 1/4W
R141, 142		RD14NB2E22J	RD 8.2K		J 1/4W
R145, 146		RS14K83D100J	FL-PROOF RS 10		J 2W
R151		RD14NB2E100J	RD 10		J 1/4W
R152		RD14GB2E100J	FL-PROOF RD 10		J 1/4W
R155		RD14NB2E151J	RD 150		J 1/4W
R155		RD14NB2E220J	RD 22		J 1/4W
R217, 218		RD14NB2E21J	RD 220		J 1/4W
R223, 224		RD14NB2E21J	RD 270		J 1/4W
R225, 226		RD14NB2E21J	RD 220		J 1/4W
R237-240		RD14NB2E220J	RD 22		J 1/4W
R243, 244		RD14NB2E22J	RD 8.2K		J 1/4W
R247, 248		RS14K83D100J	FL-PROOF RS 10		J 2W
R253, 254		RD14NB2E100J	RD 10		J 1/4W
R270		RS14KB3DS32J	FL-PROOF RS 3.3K		J 2W
R285		RD14NB2E102J	RD 1.0K		J 1/4W
R285		RD14NB2E21J	RD 820		J 1/4W
R303		RD14NB2E2R2J	RD 2.2		J 1/4W
R304		RD14NB2E100J	RD 10		J 1/4W
R307, 308		RD14NB2E4R7J	RD 4.7		J 1/4W
R309, 310		RD14NB2E2R2J	RD 2.2		J 1/4W
R312, 313		RD14NB2E100J	RD 10		J 1/4W
R314		RD14NB2E101J	RD 100		J 1/4W
R319, 320		RD14NB2E561J	RD 560		J 1/4W
R321		RD14NB2E681J	RD 680		J 1/4W
R321		RD14NB2E151J	RD 150		J 1/4W
R321		RD14NB2E821J	RD 820		J 1/4W
R322		RD14NB2E102J	RD 1.0K		J 1/4W
R322		RD14NB2E821J	RD 820		J 1/4W
R323		RD14NB2E150J	RD 15		J 1/4W
VR1 - 4		R12-1616-05	TRIMMING POT. (1K)		
K1		SS1-2078-05	MAGNETIC RELAY		
K1		SS1-2092-05	MAGNETIC RELAY		
K2		S76-0005-05	MAGNETIC RELAY		
K3		S76-0016-05	MAGNETIC RELAY		
K3		S76-0017-05	MAGNETIC RELAY		
K4		S76-0002-05	MAGNETIC RELAY		
K4		S76-0009-05	MAGNETIC RELAY		
K5		S76-0036-05	MAGNETIC RELAY		
S1		S62-0001-05	SLIDE SWITCH (AC VOLTAGE SEL)		YM
S2		S31-2322-05	SLIDE SWITCH (AC VOLTAGE SEL)		M
S2		S62-0001-05	SLIDE SWITCH (AC VOLTAGE SEL)		Y
S3		S62-0034-05	SLIDE SWITCH (IMPEDANCE SEL)		TE
D1 - 8		HSS104A	DIODE		
D1 - 8		HSS131	DIODE		
D9 - 14		HSS104	DIODE		
D9 - 14		HSS133	DIODE		
D15		HZS15N(B2)	ZENER DIODE		
D15		RD15BS(B2)	ZENER DIODE		
D16, 17		HSS104A	DIODE		

* New Parts
 Parts without Parts No. are not supplied.
 Les articles non mentionnés dans le Parts No. ne sont pas fournis.
 Teile ohne Parts No. werden nicht geliefert.

Ref. No. 参照番号	Address 位置	Parts No. 部品番号	Description 部品名 / 規格	Desti- nation 向	Re- marks 備考
C230		CE04LW1C220M	ELECTRØ 220UF		
C231		CE04LW0J221M	ELECTRØ 220UF		16WV
C232, 233		CE04LW2A470M	ELECTRØ 470UF		6.3WV
C236		CE04LW1C101M	ELECTRØ 100UF		16WV
C237		CE04LW0J471M	ELECTRØ 470UF		6.3WV
C238		CE04HW1H2R2M	NP-ELEC 2.2UF		50WV
C241		CK45FF1H472Z	CERAMIC 4700PF		Z
C242		CK45FF1H103Z	CERAMIC 0.010UF		Z
C243, 244		CE04LW2A470M	ELECTRØ 470UF		100WV
C251, 252		CC45FSL1H101J	CERAMIC 100PF		J
C301		CE04LW1A101M	ELECTRØ 100UF		10WV
C302, 303		CF92FV1H104J	MF 0.10UF		J
C304		CE04LW1V471M	ELECTRØ 470UF		35WV
C305-308		CK45FF1H103Z	CERAMIC 0.010UF		Z
C309, 310		C91-1488-05	MF 6800PF		250VAC
C314, 315		CE04LW1V222M	ELECTRØ 2200UF		35WV
C317, 318		CK45FF1H103Z	CERAMIC 0.010UF		Z
C320-323		CF92FV1H104J	MF 0.10UF		Z
C324, 325		CE04LW1C351M	ELECTRØ 350UF		16WV
C327, 328		CK45FF1H103Z	CERAMIC 0.010UF		Z
C331-334		CK45FE2H103P	CERAMIC 0.010UF		P
C335-338		C093HP2A103J	MYLAR 0.010UF		J
C339, 340		C90-3536-05	ELECTRØ 6800UF		71WV
C341		CE04LW1V4R7M	ELECTRØ 4.7UF		35WV
C342		CE04LW1J470M	ELECTRØ 470UF		63WV
C343		CE04LW1V471M	ELECTRØ 470UF		35WV
C345, 346		CK45FF1H103Z	CERAMIC 0.010UF		Z
J1		E11-0127-05	PHONE JACK (3P) PHONES		
J3		E70-0048-05	LOCK TERMINAL BOARD FRT/SUR SP		
J4		E20-0236-05	LOCK TERMINAL BOARD CENTER SP		
J11		E03-0149-05	AC OUTLET		
J13		E03-0148-05	AC OUTLET		
F1, 2		F05-2525-05	FUSE (SEMKØ) (250V T2.5AL)		YM
F2		F05-2525-05	FUSE (SEMKØ) (250V T2.5AL)		XTE
F2		F05-6029-05	FUSE (UL) (125V 6A)		KPR
F3		F05-3121-05	FUSE (SEMKØ) (350V T3.15A)		M
F5		F04-2025-05	FUSE (UL) (250V 2A)		KPR
F5		F06-2021-05	FUSE (SEMKØ) (250V T2AL)		YMXTE
CN11, 12		J13-0075-05	FUSE CLIP		YM
CN13, 14		J13-0075-05	FUSE CLIP		YM
CN15, 16		J13-0075-05	FUSE CLIP		ME
CN21, 22		J11-0098-05	WIRE CLAMP		
J8, 9		L39-0085-05	PHASE COMPENSATION COIL		
L1 - 4		L07-0864-05	POWER TRANSFORMER		KPR
T1		L07-0865-05	POWER TRANSFORMER		YM
T1		L07-0866-05	POWER TRANSFORMER		XT
T1		L07-0867-05	POWER TRANSFORMER		E
F	1B	N30-3008-46	PAN HEAD MACHINE SCREW		
CP1, 2		R90-0840-05	RD MULTIPLE RESISTOR		5W

L:Scandinavia
 Y:PK(Far East, Hawaii)
 Y:AFES(Europe)

K:USA
 T:England
 X:Australia

P:Canada
 E:Europe
 M:Other Areas

R:Mexico

△ indicates safety critical components

PARTS LIST

* New Parts
Parts without Parts No. are not supplied.
Les articles non mentionnés dans le Parts No. ne sont pas fournis.
Teile ohne Parts No. werden nicht geliefert.

Ref. No. 参照番号	Address 位置	New Parts 新部品	Parts No. 部品番号	Description 部品名 / 規格	Desti- nation 向	Re- marks 備考
C9, 10			CC45FSL1H221J	CERAMIC		
C11, 12			CF92FV1H332J	MF		J
C13, 14			CF92FV1H123J	MF		J
C15, 16			CE04LW1V100M	ELECTRØ		35WV
C17, 18			CE04LW1V220M	ELECTRØ		35WV
C19, 36			CC45FSL1H221J	CERAMIC		J
C37, 38			CE04LW1V100M	ELECTRØ		35WV
C39, 40			CE04LW1H2R2M	ELECTRØ		50WV
C41, 42			CC45FSL1H560J	CERAMIC		J
C43			CE04LW1V100M	ELECTRØ		35WV
C44, 45			CC45FSL1H560J	CERAMIC		J
C46, 48			CE04LW1V100M	ELECTRØ		35WV
C49, 50			CC45FSL1H220J	CERAMIC		J
C51, 52			CE04LW1V100M	ELECTRØ		35WV
C53, 54			CE04LW1V4R7M	ELECTRØ		4.7UF 35WV
C55, 56			CE04LW1H2R2M	ELECTRØ		2.2UF 50WV
C59, 60			CF92FV1H101J	MF		0.10UF J
C61, 62			CE04LW1V4R7M	ELECTRØ		4.7UF 35WV
C63, 64			C90-3244-05	ELECTRØ		10UF 35WV
C65, 66			CC45FSL1H221J	CERAMIC		220PF J
C67, 68			CF92FV1H563J	MF		0.056UF J
C69, 70			CC45FSL1H560J	CERAMIC		560PF J
C71, 72			CK45FB1H561K	CERAMIC		560PF K
C73, 76			C90-3244-05	ELECTRØ		10UF 35WV
C77, 78			CF92FV1H393J	MF		0.039UF J
C100			CE04LW1E470M	ELECTRØ		47UF 25WV
C101			CF92FV1H104J	MF		0.10UF J
C102-106			CE04LW1E470M	ELECTRØ		47UF 25WV
C107, 108			CK45FF1H103Z	CERAMIC		0.010UF Z
C109, 110			CE04LW1E101M	ELECTRØ		100UF 25WV
C111, 112			CF92FV1H104J	MF		0.10UF J
C113-118			CE04LW1E470M	ELECTRØ		47UF 25WV
C119, 120			C90-3244-05	ELECTRØ		10UF 35WV
C151, 152			CC45FSL1H101J	CERAMIC		100PF J
C152, 153			CE04LW1A471M	ELECTRØ		470UF 10WV
C154			CC45FSL1H101J	CERAMIC		100PF J
C173, 174			CC45FSL1H560J	CERAMIC		560PF J
C175, 176			CE04LW1V4R7M	ELECTRØ		4.7UF 35WV
C177, 178			CE04LW1H2R2M	ELECTRØ		2.2UF 50WV
C179, 180			CE04LW1V4R7M	ELECTRØ		4.7UF 35WV
C181, 182			CC45FSL1H560J	CERAMIC		560PF J
C201			C90-1827-05	BACKUP		0.047F 5.5WV
C202			C90-3222-05	ELECTRØ		100UF 10WV
C203			C90-3253-05	ELECTRØ		1UF 50WV
C204			CK45FF1H103Z	CERAMIC		0.010UF Z
C205, 206			CF92FV1H104J	MF		0.10UF J
C207			CK45FB1H102K	CERAMIC		1000PF K
C208, 209			C91-0749-05	CERAMIC		220PF K
C210-212			CC45FSL1H101J	CERAMIC		100PF J
C213			CC45FSL1H221J	CERAMIC		220PF J
C214			CK45FB1H102K	CERAMIC		1000PF K
C215			CC45FSL1H221J	CERAMIC		220PF J
C216-219			C91-0085-05	CERAMIC		0.022UF N
C220			C90-3253-05	ELECTRØ		1UF 50WV
C221, 222			CC45FSL1H221J	CERAMIC		220PF J

L:Scandinavia
Y:PA(Far East, Hawaii)
Y:AAFE(S/Europe)

M:USA
T:England
X:Australia
M:Other Areas

R:Mexico

B:KA-894
9:KA-994

V:KA-V3700

△ indicates safety critical components

* New Parts
Parts without Parts No. are not supplied.
Les articles non mentionnés dans le Parts No. ne sont pas fournis.
Teile ohne Parts No. werden nicht geliefert.

Ref. No. 参照番号	Address 位置	New Parts 新部品	Parts No. 部品番号	Description 部品名 / 規格	Desti- nation 向	Re- marks 備考
D102			KBP02M1-6127	DIODE		
D103, 104			HSS104A	DIODE		
D105, 106			1SS131	DIODE		
D107, 108			5S4488	DIODE		
D109, 110			1SR139-100	DIODE		
D109, 110			D55BA20F03	DIODE		
D111, 112			REV-602LFA	DIODE		
D114, 115			SS6888	DIODE		
D114, 115			1SR139-100	DIODE		
D116			HZS15N(B2)	ZENER DIODE		
D116			RD15ES(B2)	ZENER DIODE		
D117			HZS16N(B2)	ZENER DIODE		
D117			RD16ES(B2)	ZENER DIODE		
IC5			TA78057S	IC(VOLTAGE REGULATOR/+5.75V)		
IC6			TA79015S	IC(VOLTAGE REGULATOR/-15V)		
IC6			UPC7915HF	IC(VOLTAGE REGULATOR/-15V)		
IC7			TA7815S	IC(VOLTAGE REGULATOR/+15V)		
IC7			UPC7815AHF	IC(VOLTAGE REGULATOR/+15V)		
Q1, 2			2SC2878(B)	TRANSISTOR		
Q3, 6			2SA992(F,E)	TRANSISTOR		
Q7, 10			2SC2632(R,S)	TRANSISTOR		
Q11, 12			2SA1124(R,S)	TRANSISTOR		
Q13, 14			2SC4137	TRANSISTOR		
Q15, 16			2SB1594LB	TRANSISTOR		
Q17, 18			2SD2449LB	TRANSISTOR		
Q19, 20			2SC2631(R,S)	TRANSISTOR		
Q21, 22			2SC2878(B)	TRANSISTOR		
Q24			2SA992(F,E)	TRANSISTOR		
Q26			2SA992(F,E)	TRANSISTOR		
Q28			2SC2631(R,S)	TRANSISTOR		
Q30			2SC2631(R,S)	TRANSISTOR		
Q32			2SA1123(R,S)	TRANSISTOR		
Q34			2SC4137	TRANSISTOR		
Q36			2SD2255BT	TRANSISTOR		
Q38			2SB1493BT	TRANSISTOR		
Q40			2SC1845(F,E)	TRANSISTOR		
Q41			2SA1175(F,E)	TRANSISTOR		
Q41			2SA433(Q,R)	TRANSISTOR		
Q42			2SA922(F,E)	TRANSISTOR		
Q43, 44			2SC1845(F,E)	TRANSISTOR		
Q45-47			2SC2003(L,K)	TRANSISTOR		
Q48			2SA1175(F,E)	TRANSISTOR		
Q48			2SA935(Q,R)	TRANSISTOR		
Q49			2SC2003(L,K)	TRANSISTOR		
Q50			2SC2878(B)	TRANSISTOR		
Q51			2SC2003(L,K)	TRANSISTOR		
Q52			2SB1370	TRANSISTOR		
Q52			2SB1375	TRANSISTOR		
D317			KA-894/994/V3700 CONTROL UNIT (X11-350X-XX)	LED(RED)		
C1, 2			B310-2461-05	LED(RED)		STAND BY
C3, 4			CC45FSL1H221J	CERAMIC		220PF J
C5, 6			CE04LW1V100M	ELECTRØ		10UF 35WV
C7, 8			CC45FSL1H221J	CERAMIC		220PF J
			CE04LW1A101H	ELECTRØ		100UF 10WV

L:Scandinavia
Y:PA(Far East, Hawaii)
Y:AAFE(S/Europe)

M:USA
T:England
X:Australia
M:Other Areas

R:Mexico

B:KA-894
9:KA-994

V:KA-V3700

△ indicates safety critical components

PARTS LIST

* New Parts
 Parts without Parts No. are not supplied.
 Les articles non mentionnés dans le Parts No. ne sont pas fournis.
 Teile ohne Parts No. werden nicht geliefert.

Ref. No. 参照番号	Address 位置	Parts No. 部品番号	Description 部品名 / 規格	Re- marks 向備考
R141, 142		RD14NB2E822J	RD FL-PROOF RS 10 J 1/4W	
R145, 146		RS14KB3D100J	RD FL-PROOF RS 10 J 2W	
R151		RD14NB2E100J	RD FL-PROOF RD 10 J 1/4W	
R152		RD14NB2E100J	RD FL-PROOF RD 10 J 1/4W	
R155		RD14NB2E151J	RD 150 J 1/4W	
R218		RD14NB2E221J	RD 220 J 1/4W	
R224		RD14NB2E271J	RD 270 J 1/4W	
R226		RD14NB2E221J	RD 220 J 1/4W	
R238		RD14NB2E220J	RD 220 J 1/4W	
R240		RD14NB2E220J	RD 220 J 1/4W	
R244		RD14NB2E822J	RD 8.2K J 1/4W	
R248		RS14KB3D100J	RD FL-PROOF RS 10 J 2W	
R254		RD14NB2E100J	RD FL-PROOF RS 10 J 1/4W	
R270		RS14KB3D332J	RD FL-PROOF RS 3.3K J 2W	
R303		RD14NB2E2R2J	RD 2.2 J 1/4W	
R304		RD14NB2E100J	RD 10 J 1/4W	
R307, 308		RD14NB2E4R7J	RD 4.7 J 1/4W	
R309, 310		RD14NB2E2R2J	RD 2.2 J 1/4W	
R312, 313		RD14NB2E100J	RD 10 J 1/4W	
R314		RD14NB2E101J	RD 100 J 1/4W	
R319, 320		RD14NB2E821J	RD 820 J 1/4W	
R321		RD14NB2E151J	RD 150 J 1/4W	
VR1, 2		R12-1616-05	TRIMMING POT. (1K)	
VR4		R12-1616-05	TRIMMING POT. (1K)	
K1		S51-2078-05	MAGNETIC RELAY	
K1		S51-2092-05	MAGNETIC RELAY	
K2		S76-0005-05	MAGNETIC RELAY	
K3		S76-0016-05	MAGNETIC RELAY	
K3		S76-0017-05	MAGNETIC RELAY	
K4		S76-0002-05	MAGNETIC RELAY	
K5		S76-0036-05	MAGNETIC RELAY	
S1		S31-2322-05	SLIDE SWITCH (AC VOLTAGE SEL)	YM
S2		S62-0001-05	SLIDE SWITCH (AC VOLTAGE SEL)	M
S2		S62-0001-05	SLIDE SWITCH (AC VOLTAGE SEL)	Y
D1 -4		HSS104A	DIODE	
D1 -4		HSS131	DIODE	
D6		HSS104A	DIODE	
D6		HSS131	DIODE	
D8		HSS104A	DIODE	
D8		HSS131	DIODE	
D9 -14		HSS104	DIODE	
D9 -14		HSS133	DIODE	
D15		HZ515M(B2)	ZENER DIODE	
D15		RD15ES(B2)	ZENER DIODE	
D16 -19		HSS104A	DIODE	
D16 -19		HSS131	DIODE	
D20		HZ54.7M(B2)	ZENER DIODE	
D20		RD4.7ES(B2)	ZENER DIODE	
D25 -30		HSS104	DIODE	
D25 -30		HSS133	DIODE	
D35		HSS104A	DIODE	
D35		HSS131	DIODE	
D101		HSS104	DIODE	
D101		HSS133	DIODE	

* New Parts
 Parts without Parts No. are not supplied.
 Les articles non mentionnés dans le Parts No. ne sont pas fournis.
 Teile ohne Parts No. werden nicht geliefert.

Ref. No. 参照番号	Address 位置	Parts No. 部品番号	Description 部品名 / 規格	Re- marks 向備考
C238		CE04HW1H2R2M	NP-ELEC 2.2UF 50V	
C239		CE04HW1H2R2M	NP-ELEC 4.70UF 50V	
C241		CK45FF1H47Z2	CERAMIC 4.70UF Z	
C242		CK45FF1H103Z	CERAMIC 0.010UF J	
C252		CC45FSL1H101J	CERAMIC 100PF Z	
C301		CE04LW1A101M	ELECTRO 100UF 10WV	
C302, 303		CF92EV1H104J	MF 0.10UF J	
C304		CE04LW1V471M	ELECTRO 470UF 35WV	
C305-308		CK45FF1H103Z	CERAMIC 0.010UF Z	
C309, 310		C91-1488-05	6800PF 250VAC	
C314, 315		CE04LW1V222M	ELECTRO 2200UF 35WV	
C317, 318		CK45FF1H103Z	CERAMIC 0.010UF Z	
C320-323		CF92EV1H104J	MF 0.10UF J	
C324, 325		CE04LW1C311M	ELECTRO 330UF 16WV	
C327, 328		CK45FF1H103Z	CERAMIC 0.010UF Z	
C331-334		CK45FE2H103P	CERAMIC 0.010UF P	
C335-338		CO3HP2A103J	MYLAR 0.010UF J	
C339, 340		C90-3536-05	ELECTRO 6800UF 71WV	
C341		CE04LW1V471M	ELECTRO 4.7UF 35WV	
C342		CE04LW1J470H	ELECTRO 470UF 63WV	
C343		CE04LW1V471M	ELECTRO 470UF 35WV	
C345, 346		CK45FF1H103Z	CERAMIC 0.010UF Z	
J1		E11-0127-05	PHONE JACK (3P) PHONES	
J2		E63-0090-05	PHONE JACK (2P) S.W/CT PRE OUT	
J3		E70-0048-05	LOCK TERMINAL BOARD PRT/SUR SP	
J7		E63-0072-15	PHONE JACK (2P) L/R LINE OUT	M
J11		E03-0149-05	AC OUTLET	KPYR
J13		E03-0148-05	AC OUTLET	KPYR
F1, 2		F05-2525-05	FUSE (SEMØ) (250V T2.5AL)	YM
F2		F04-5022-05	FUSE (UL) (125V 5A UL)	KPR
F2		F05-2525-05	FUSE (SEMØ) (250V T2.5AL)	X
F3		F05-3121-05	FUSE (SEMØ) (250V T3.15AL)	M
F5		F04-2025-05	FUSE (UL) (250V 2A)	KPR
F5		F06-2021-05	FUSE (SEMØ) (250V T2AL)	YMX
CN11, 12		J13-0075-05	FUSE CLIP	YM
CN13, 14		J13-0075-05	FUSE CLIP	M
CN15, 16		J13-0075-05	FUSE CLIP	
CN21, 22		J13-0075-05	FUSE CLIP	
J8, 9		J11-0098-05	WIRE CLAMPER	
L1, 2		L39-0065-05	PHASE COMPENSATION COIL	KPR
L4		L07-0864-05	POWER TRANSFORMER	YM
T1		L07-0864-05	POWER TRANSFORMER	X
T1		L07-0865-05	POWER TRANSFORMER	
T1		L07-0866-05	POWER TRANSFORMER	
F	1B	N30-3008-46	PAN HEAD MACHINE SCREW	
CP1, 2		R90-0840-05	RD 0.22 SW	
CP4		R90-0888-05	MULTIPLE RESISTOR	
R41, 42		RS14KB3D561J	FL-PROOF RS 560 J 2W	
R117, 118		RD14NB2E221J	RD 220 J 1/4W	
R123, 124		RD14NB2E271J	RD 270 J 1/4W	
R125, 126		RD14NB2E221J	RD 220 J 1/4W	
R127, 128		RD14NB2E271J	RD 270 J 1/4W	

L:Scandinavia K:USA P:Canada R:Mexico
 Y:PX(Far East, Hawaii) T:England E:Europe
 Y:AAE(Europe) X:Australia M:Other Areas

△ indicates safety critical components.

PARTS LIST

* New Parts
 Parts without Parts No. are not supplied.
 Les articles non mentionnés dans le Parts No. ne sont pas fournis.
 Teile ohne Parts No. werden nicht geliefert.

Ref. No. 参照番号	Address 位置	New Part 新	Parts No. 部品番号	Description 部品名 / 規格	Desti- nation 向	Re- marks 備考
IC11			TC9215P	IC(ANALOG SWITCH X 6)	9V	
IC12			NJM2279D	IC(VIDEO IC)		
IC13			NJU7313L	IC(ANALOG SWITCH)		
IC13			TC9164N	IC(16CH BILATERAL SELECTOR SW)		
IC14			LA2785	IC		
IC15			LV1010	DI BI-POLAR IC		
IC16			TC9212P	IC(ELECTRICAL VOLUME)		
IC17			TC9215P	IC(ANALOG SWITCH X 6)		
IC18			CX862320-162Q	MI-COM IC		
IC19			S-80740AL	IC(VOLTAGE DETECTOR)		
IC20			TC9215P	IC(ANALOG SWITCH X 6)		
IC21, 22			NJM4580L	IC(OP AMP X2)		
Q1 - 4			25C174DS(Q,R)	TRANSISTOR		
Q1 - 4			25C2785(F,E)	TRANSISTOR		
Q5			25D2012	TRANSISTOR		
Q5			25D2061(E,F)	TRANSISTOR		
Q6			25C2878(B)	TRANSISTOR		
A1			W02-1046-05	ELECTRIC CIRCUIT MODULE		
A1			W02-1174-05	ELECTRIC CIRCUIT MODULE		
A1		*	W02-1188-05	ELECTRIC CIRCUIT MODULE		

L:Scandinavia
 Y:PX(Far East, Hawaii)
 Y:AFES(Europe)

K:USA
 T:England
 X:Australia

P:Canada
 E:Europe
 M:Other Areas

R:Mexico
 B:KA-894
 B:KA-994

V:KA-V3700

Δ indicates safety critical components

PARTS LIST

* New Parts

Parts without Parts No. are not supplied.
Les articles non mentionnés dans la Parts No. ne sont pas fournis.
Teile ohne Parts No. werden nicht geliefert.

Ref. No. 参照番号	Address 位置	Parts No. 部品番号	Description 部品名 / 規格	Desti- nation 仕	Re- marks 備考
J1		E63-0047-15	PHONE JACK (6P) ADPT IN/TAPE		
J2		E63-0070-15	PHONE JACK (6P) V1/V2/ADPT OUT		
J3		E63-0046-15	PHONE JACK (4P) TUNER/CD INPUT		
J4		E63-0068-15	PHONE JACK (2P) PHONE		
J5		E11-0188-05	MINIATURE PHONE JACK S. CONTROL		
J6		E63-0069-15	PHONE JACK (4P) M. OUT/V1/V2 IN	9V	
X1		L78-0294-05	RESONATOR (10.000MHz)		
X2		L78-0290-05	RESONATOR (8MHz)		
CP1		R90-0816-05	MULTI-COMP 47K X7		
CP2		R90-0487-05	MULTI-COMP 47KX4 J 1/6W		
R101-104		RD146B2681J	FL-PR00F RS 680 J 1/4W		
R113		RS14KB30220J	FL-PR00F RS 22 J 2W		
R319		RN14BK263902F	RN 39.0K F 1/6W		
VR1-2		R10-5076-05	POTENTIOMETER(100K X2)		
VR3		R12-1086-05	TRIMMING POTENTIOMETER(2.2K)		
S1 -17		S40-1064-05	PUSH SWITCH (SURROUND MODE)		
S18		T99-0547-05	SPEED DETECTOR		
S19		T99-0548-05	SPEED DETECTOR		
D201-203		HSS104	DIODE	9V	
D201-203		SS133	DIODE	9V	
D204		HSS104	DIODE	9	
D204		SS133	DIODE		
D205		HSS104	DIODE		
D205		SS133	DIODE		
D206-224		HSS104	DIODE		
D206-224		SS133	DIODE		
D301-302		HSS104	DIODE		
D301-302		SS133	DIODE		
D301-302		HSS104	DIODE		
D301-302		SS133	DIODE		
D303-304		HSS104	DIODE	9V	
D303-304		SS133	DIODE	9V	
D305-310		HSS104	DIODE		
D305-310		SS133	DIODE		
D311-312		HZ55-1N(B2)	ZENER DIODE	9V	
D311-312		RD5-1ES(B2)	ZENER DIODE		
D313-314		HSS104	DIODE	9V	
D313-314		SS133	DIODE		
D315		HZ510N(B2)	ZENER DIODE		
D315		RD10ES(B2)	ZENER DIODE		
D316		HZ55-6N(B2)	ZENER DIODE		
D316		RD5-6ES(B2)	ZENER DIODE		
D318-321		HZ513N(B2)	ZENER DIODE		
D318-321		RD13ES(B2)	ZENER DIODE		
D322-327		HSS104	DIODE		
D322-327		SS133	DIODE		
ED1		FD11SM8R	INDICATOR TUBE		
IC1		NJM4580-D	IC(OP AMP X2)		
IC2		NJM2058D	IC(OP AMP X4)		
IC3		NJM4560L	IC(OP AMP X2)		
IC4-7		NJM4558D	IC(OP AMP X2)		
IC8		NJM4560L	IC(OP AMP X2)		
IC9		TC9213P	IC(ZCH ELECTRONIC VOLUME)		
IC10		NJM4560L	IC(OP AMP X2)		

* New Parts

Parts without Parts No. are not supplied.
Les articles non mentionnés dans la Parts No. ne sont pas fournis.
Teile ohne Parts No. werden nicht geliefert.

Ref. No. 参照番号	Address 位置	Parts No. 部品番号	Description 部品名 / 規格	Desti- nation 仕	Re- marks 備考
C223		CF92FV1H104J	MF 0.10UF J		
C224		C90-3258-05	10UF 50WV		
C225-229		CK45FF1H103Z	CERAMIC 0.010UF Z		
C230		CK45SL1H221J	220PF K		
C231-232		C91-0749-05	220PF K		
C233		CK45FF1H103Z	CERAMIC 0.010UF Z		
C301-304		CE04LW1E470M	ELECTRO 4.7UF 25WV		
C305-307		CE04LW1V4R7M	ELECTRO 4.7UF 35WV		
C308		CE04LW1V470M	ELECTRO 4.7UF 50WV		
C309		CE04LW1H2R2M	ELECTRO 2.2UF 50WV		
C310		CE04LW1C221M	ELECTRO 220UF 16WV		
C311-312		C90-3258-05	ELECTRO 4.7UF 50WV		
C313		CE04LW1H010M	ELECTRO 1.0UF 50WV		
C314		CE04LW1C221M	ELECTRO 220UF 16WV		
C315		CE04LW1H010M	ELECTRO 1.0UF 50WV		
C316		CF92FV1H104J	MF 0.10UF J		
C317		CF92FV1H105J	MF 1.0UF J		
C318		CF92FV1H333J	MF 0.033UF J		
C319		CF92FV1H152J	MF 1500PF J		
C320		CF92FV1H333J	MF 0.033UF J		
C321		CE04LW1V100M	ELECTRO 10UF 35WV		
C322		CE04LW1H2R2M	ELECTRO 2.2UF 50WV		
C323		CF92FV1H154J	MF 0.15UF J		
C324		CE04LW1H3R3M	ELECTRO 3.3UF 50WV		
C325		CF92FV1H154J	MF 0.15UF J		
C326		CE04LW1V4R7M	ELECTRO 4.7UF 35WV		
C327		CE04LW1HR47M	ELECTRO 4.7UF 50WV		
C328		CE04LW1V4R7M	ELECTRO 4.7UF 35WV		
C329		CE04LW1HR47M	ELECTRO 4.7UF 50WV		
C330-331		CF92FV1H104J	MF 0.10UF J		
C332		CE04LW1E470M	ELECTRO 4.7UF 25WV		
C333		CF92FV1H470J	MF 0.47UF J		
C334-337		CE04LW1V100M	ELECTRO 10UF 35WV		
C338		CK45FD1H681K	CERAMIC 680PF K		
C339		CF92FV1H154J	MF 0.15UF J		
C340		CE04LW1H3R3M	ELECTRO 3.3UF 50WV		
C341		CF92FV1H154J	MF 0.15UF J		
C342		CE04LW1V4R7M	ELECTRO 4.7UF 35WV		
C343		CE04LW1HR47M	ELECTRO 4.7UF 50WV		
C344		CE04LW1V4R7M	ELECTRO 4.7UF 35WV		
C345		CE04LW1HR47M	ELECTRO 4.7UF 50WV		
C346-347		CF92FV1H104J	MF 0.10UF J		
C348-349		CE04LW1H010M	ELECTRO 1.0UF 50WV		
C350		CE04LW1C221M	ELECTRO 220UF 16WV		
C351-354		CE04LW1V100M	ELECTRO 10UF 35WV		
C355		CE04LW1C221M	ELECTRO 220UF 16WV		
C356		CF92FV1H473J	MF 0.047UF J		
C357		CF92FV1H223J	MF 0.022UF J		
C358		CK45FF1H103Z	CERAMIC 0.010UF Z		
C359		CK45FF1H103Z	CERAMIC 0.010UF Z		
C360		CK45FF1H103Z	CERAMIC 0.010UF Z		
C361-362		CK45FF1H103Z	CERAMIC 0.010UF Z		
C363-364		CE04LW1H2R2M	ELECTRO 2.2UF 50WV		
C365		CF92FV1H104J	MF 0.10UF J		
C366		CK45FF1H103Z	CERAMIC 0.010UF Z		

L:Scandinavia K:USA P:Canada R:Mexico V:KA-V3700
 Y:PX(Far East, Hawaii) T:England E:Europe
 Y:AAFES(Europe) X:Australia M:Other Areas
 B: KA-894 V: KA-V3700
 R: KA-994
 Δ indicates safety critical components

SPECIFICATIONS

(KA-994)

For the USA, Mexico and Canada

AUDIO section

Rated power output

STEREO MODE (FTC)

100 watts per channel minimum RMS, both channels driven, at 8 Ω from 20 Hz to 20 kHz with no more than 0.09% total harmonic distortion.

SURROUND MODE

Front

100 watts per channel minimum RMS, both channels driven, at 8 Ω 1 kHz with no more than 0.9% total harmonic distortion.

Rear

20 watts per channel minimum RMS, both channels driven, at 8 Ω 1kHz with no more than 0.9% total harmonic distortion.

Total harmonic distortion
 0.06% (20 Hz ~ 20 kHz, 50 W, 8 Ω)
 0.03% (1 kHz, 50 W, 8 Ω)

Frequency response
 LINE (CD, TAPE, VIDEO)
 20 Hz ~ 60 kHz, +0 dB, -3 dB

PHONO "RIAA" response
 20 Hz ~ 20 kHz, \pm 0.5 dB

Maximum input level
 PHONO (MM) 120 mV, 0.5% T.H.D. at 1 kHz

Signal to noise ratio
 (IHF'66)
 PHONO (MM) 75 dB
 LINE (CD, TAPE, VIDEO) 95 dB

Input sensitivity / impedance
 PHONO (MM) 3.5 mV / 47k Ω
 LINE (CD, TAPE, VIDEO) 200 mV / 47k Ω
 ADAPTOR IN 200 mV / 47k Ω

Tone control
 BASS \pm 10 dB (at 100 Hz)
 TREBLE \pm 10 dB (at 10 kHz)

Loudness control (volume at -30 dB level)
 + 8 dB (at 100 Hz)

Output level / impedance
 TAPE REC 200 mV / 1 k Ω
 ADAPTOR OUT 200 mV / 1 k Ω

VIDEO section

Input level / impedance
 VIDEO (composite) 1 Vp-p/75 Ω
 Input (VIDEO 1, VIDEO 2)

Output level / impedance
 VIDEO (composite) 1 Vp-p/75 Ω
 Output (VIDEO 1, MONITOR OUT)

GENERAL

Power consumption 2.3 A

AC outlets
 SWITCHED 2: (400 W max.)

Dimensions W: 440 mm (17-5/16")
 H: 143 mm (5-5/8")
 D: 300 mm (11-13/16")

Weight (Net) 9.3 kg (20.5 lb)

Note:

KENWOOD follows a policy of continuous advancements in development. For this reason specifications may be changed without notice.

For other countries

AUDIO section

Rated power output

STEREO MODE

(IHF'66) 20 Hz~20 kHz, 0.09%

T.H.D. at 8 Ω 100 W + 100 W
 (EIAJ) 1 kHz, 10%) T.H.D. at 8 Ω 150 W + 150 W

SURROUND MODE

at 8 Ω , 1 kHz, 0.9% T.H.D.

FRONT 100 W + 100 W
 REAR 20 W + 20 W

Total harmonic distortion

..... 0.06% (20 Hz ~ 20 kHz, 50 W, 8 Ω)
 0.03% (1 kHz, 50 W, 8 Ω)

Frequency response

LINE (CD, TAPE, VIDEO)
 20 Hz ~ 60 kHz, +0 dB, -3 dB

PHONO "RIAA" response
 20 Hz ~ 20 kHz, \pm 0.5 dB

Maximum input level

PHONO (MM) 120 mV, 0.5% T.H.D. at 1 kHz

Signal to noise ratio

(IHF'66)
 PHONO(MM) 75 dB
 LINE (CD, TAPE, VIDEO) 95 dB

Input sensitivity/impedance

PHONO (MM) 3.5 mV/47 k Ω
 LINE (CD, TAPE,VIDEO) 200 mV/47 k Ω
 ADAPTOR IN 200 mV/47 k Ω

Tone control

BASS \pm 10 dB(at 100 Hz)
 TREBLE \pm 10 dB(at 10 kHz)

Loudness control (volume at-30 dB level)
 +8dB (100 Hz)

Output level/impedance

TAPE REC 200 mV/1 k Ω
 ADAPTOR OUT 200 mV/1 k Ω

VIDEO section

Input level/impedance

VIDEO (composite) 1 Vp-p/75 Ω
 Input (VIDEO 1, VIDEO 2)

Output level/impedance

VIDEO (composite) 1 Vp-p/75 Ω
 Output (VIDEO 1, MONITOR OUT)

GENERAL

Power consumption 210 W

AC outlets
 SWITCHED 2: (300 W max.)

Dimensions W: 440 mm
 H: 143 mm
 D: 300 mm

Weight (Net) 9.3 kg

SPECIFICATIONS

(KA-894)

For the USA, Mexico and Canada

AUDIO section

Rated power output (FTC)

STEREO MODE

100 watts per channel minimum RMS, both channels driven, at 8Ω from 20 Hz to 20 kHz with no more than 0.09% total harmonic distortion.

SURROUND MODE

Front

70 watts per channel minimum RMS, both channels driven, at 8 Ω 1 kHz with no more than 0.9% total harmonic distortion.

Center

70 watts at 8 Ω 1 kHz with no more than 0.9% total harmonic distortion.

Rear

20 watts per channel minimum RMS, both channels driven, at 8 Ω 1 kHz with no more than 0.9% total harmonic distortion.

Total harmonic distortion
 0.06% (20 Hz ~ 20 kHz, 50 W, 8 Ω)
 0.03% (1kHz, 50 W, 8 Ω)

Frequency response
LINE (CD, TAPE, VIDEO)
 20 Hz ~ 60 kHz, +0 dB, -3 dB

PHONO "RIAA" response
 20 Hz ~ 20 kHz, ± 0.5 dB

Maximum input level
PHONO (MM) 120 mV, 0.5% T.H.D. at 1 kHz

Signal to noise ratio
 (IHF'66)
PHONO (MM) 75 dB
LINE (CD, TAPE, VIDEO) 95 dB

Input sensitivity/impedance
PHONO (MM) 3.5 mV/47 kΩ
LINE (CD, TAPE, VIDEO) 200 mV/47 kΩ
ADAPTOR IN 200 mV/47 kΩ

Tone control
BASS ± 10 dB (at 100 Hz)
TREBLE ± 10 dB (at 10 kHz)

Loudness control (volume at -30 dB level)
 + 8 dB (100 Hz)

Output level/impedance
TAPE REC 200 mV/1 kΩ
ADAPTOR OUT 200 mV/1 kΩ

GENERAL

Power consumption 2.5 A
 250 W

AC outlets
SWITCHED 2 (400 W max.)
Dimensions W: 440 mm (17-5/16")
 H: 143 mm (5-5/8")
 D: 300 mm (11-13/16")

Weight (Net) 9.3 kg (20.5 lb)

Note:

KENWOOD follows a policy of continuous advancements in development. For this reason specifications may be change without notice.

For other countries

AUDIO section

Rated power output

STEREO MODE

(IHF'66) From 20 Hz to 20 kHz, 0.09% T.H.D.

at 8 Ω 100 W + 100 W
 (EIAJ)

1 kHz, 10% T.H.D. at 8 Ω 150 W + 150 W

SURROUND MODE

1 kHz, 0.9% T.H.D. at 8 Ω

FRONT 70 W + 70 W

CENTER 70 W

REAR 20 W + 20 W

Total harmonic distortion

..... 0.06% (20 Hz ~ 20 kHz, 50 W, 8 Ω)

..... 0.03% (1kHz, 50 W, 8 Ω)

Frequency response

LINE (CD, TAPE, VIDEO)

..... 20 Hz ~ 60 kHz, +0 dB, -3 dB

PHONO "RIAA" response

..... 20 Hz ~ 20 kHz, ± 0.5 dB

Maximum input level

PHONO (MM) 120 mV, 0.5% T.H.D. at 1 kHz

Signal to noise ratio

(IHF'66)

PHONO (MM) 75 dB

LINE (CD, TAPE, VIDEO) 95 dB

Input sensitivity/impedance

PHONO (MM) 3.5 mV/47 kΩ

LINE (CD, TAPE, VIDEO) 200 mV/47 kΩ

ADAPTOR IN 200 mV/47 kΩ

Tone control

BASS ± 10 dB (at 100 Hz)

TREBLE ± 10 dB (at 10 kHz)

Loudness control (volume at -30 dB level)

..... + 8 dB (100 Hz)

Output level/impedance

TAPE REC 200 mV/1 kΩ

ADAPTOR OUT 200 mV/1 kΩ

GENERAL

Power consumption 250W

AC outlet

SWITCHED 300 W mix

Dimensions W: 440 mm

H: 143 mm

D: 300 mm

Weight (Net) 9.3 kg

2SA1123
 2SA1124
 2SA992
 2SC1845
 2SC2003
 2SC2631
 2SC2632
 2SC2878

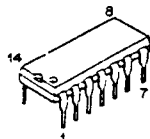
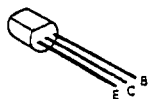

NJM2058D
 NJM2279D

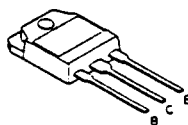

2SB1493BT
 2SD2255BT

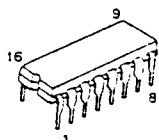

TC9212P
 TC9213P
 TC9215P

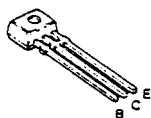

2SA1175
 2SC2785

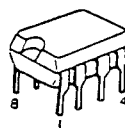

NJM4580D-D
 NJM4580L

1010

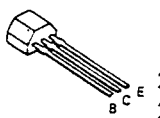
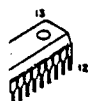

2SA933S
 2SC1740S

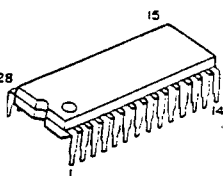

NJU7313L

LA2785

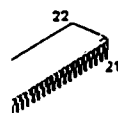

2SC4137



UPC7815AIF

2SB1370
 2SD2061

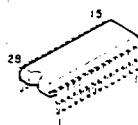

TC9164N



TA79015S

2SB1375
 2SD2012

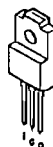

TA7815S

B

2SB1594LB
 2SD2449LB

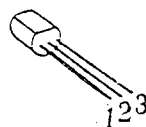

UPC7915HF

NJM4558D

KA-894/994/V3700

SPECIFICATIONS

(KA-V3700)

AUDIO section

Rated power output

STEREO MODE

(DIN) 1 kHz

at 8 Ω	100 W + 100 W
at 4 Ω	80 W + 80 W

SURROUND MODE

(IHF 66) 1 kHz, 0.9 % T.H.D.at 8 Ω

FRONT	70 W + 70 W
CENTER	70 W
REAR	20 W + 20 W

Total harmonic distortion

.....	0.06% (20 Hz ~ 20 kHz, 50 W, 8 Ω)
.....	0.03% (1 kHz, 50 W, 8 Ω)

Frequency response

LINE (CD, TAPE, VIDEO)

..... 20 Hz ~ 55 kHz, + 0 dB, -3 dB

PHONO "RIAA" response 20 Hz ~ 20kHz, \pm 0.5 dB

Maximum input level

PHONO (MM) 120 mV, 0.5% T,H,D, at 1 kHz

Signal to noise ratio

(DIN)

PHONO(MM)	55 dB (50 mW output)
LINE (CD, TAPE, VIDEO)	57 dB (50 mW output)

Input sensitivity/impedance

PHONO (MM)	3.5 mV/47 k Ω
LINE (CD, TAPE,VIDEO)	200 mV/47 k Ω
ADAPTOR IN	200 mV/47 k Ω

Tone control

BASS	\pm 10 dB(at 100 Hz)
TREBLE	\pm 10 dB(at 10 kHz)

Loudness control (volume at-30 dB level)

..... + 8 dB (100 Hz)

Output level/impedance

TAPE REC	200 mV/1 k Ω
ADAPTOR OUT	200 mV/1 k Ω

VIDEO section

Input level/impedance

VIDEO (composite)	1 Vp-p/75 Ω
Input (VIDEO 1, VIDEO 2)	

Output level/impedance

VIDEO (composite)	1 Vp-p/75 Ω
Output (VIDEO 1, MONITOR OUT)	

GENERAL

Power consumption 320 W

AC outlets

SWITCHED (300 W max.)

Dimensions

W: 440 mm
H: 143 mm
D: 300 mm

Weight (Net) 9.3 kg

Note:

KENWOOD follows a policy of continuous advancements in development. For this reason specifications may be changed without notice.